

CC 1024 RD-N > 13CI51AN603 (2011) > MOTORZUBEHÖR

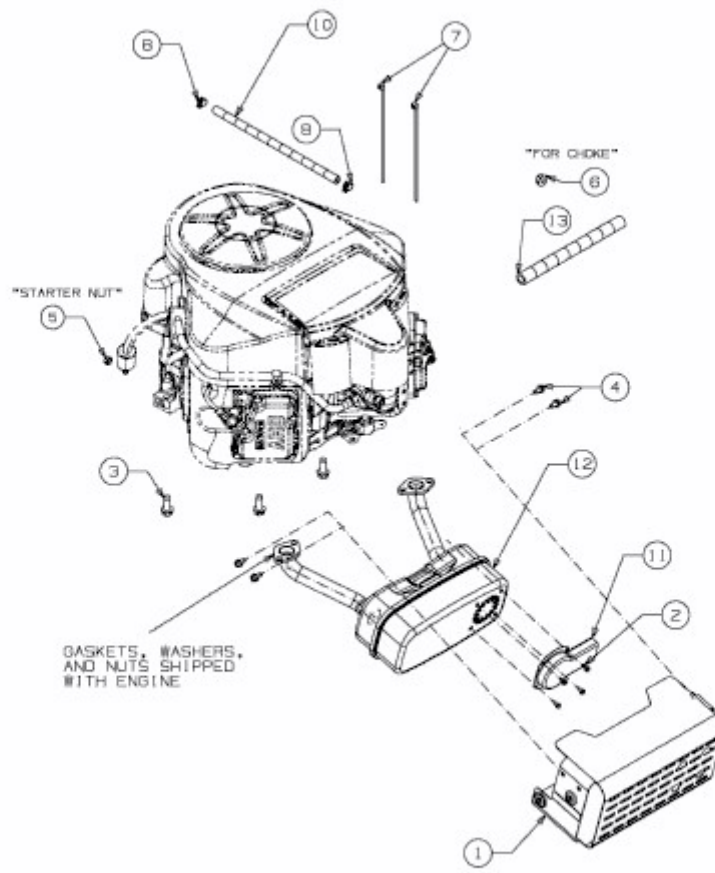

E3-05295B-01