

HE 5150 K > 13CI514E671 (2007) > FÜLLSTANDSANZEIGE

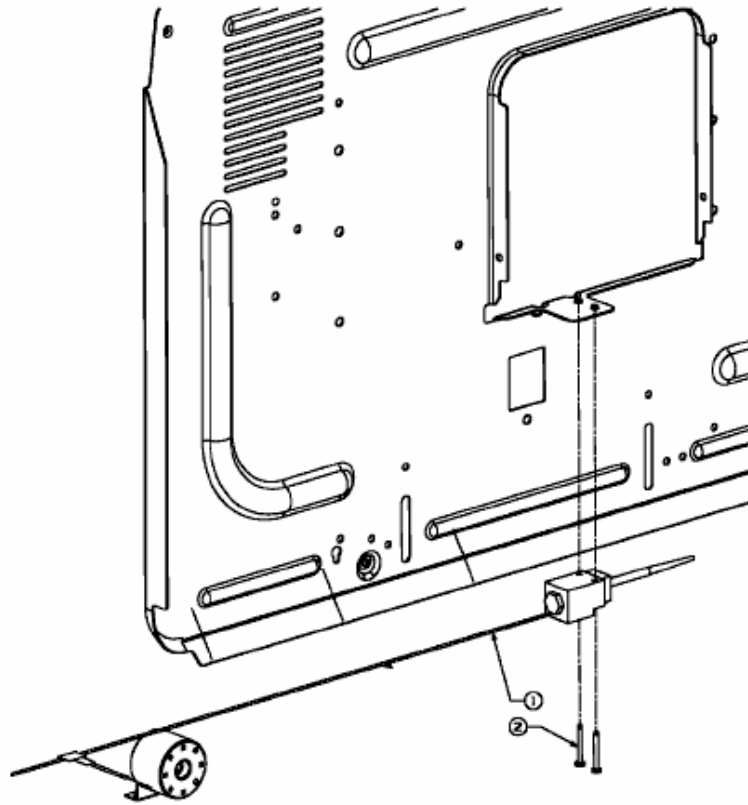

E3-02081A-01