

HE 5150 K > 13CI514E671 (2007) > ARMATURENBRETT

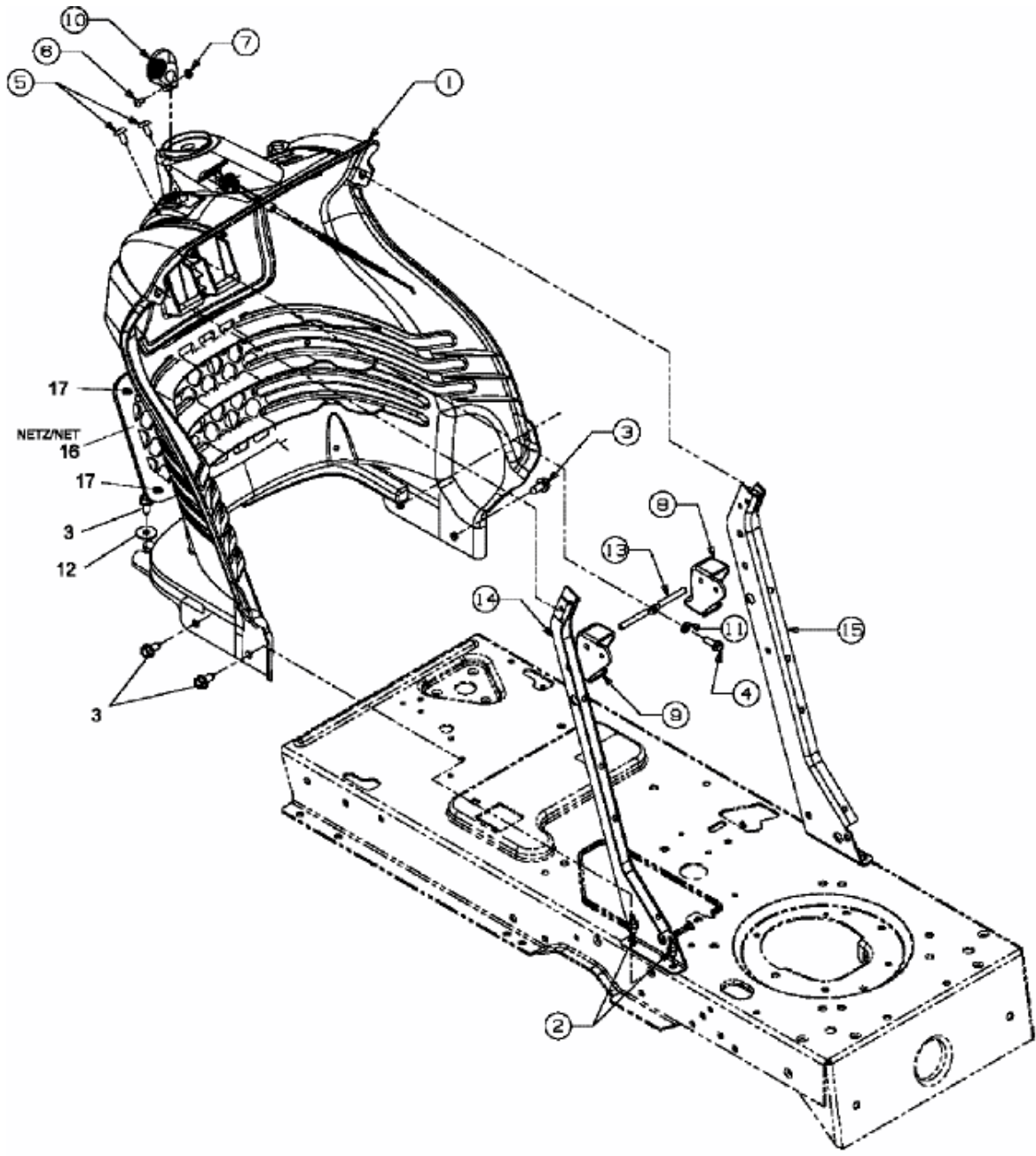

E3-02017B-01