

HE 5150 K > 13CI514E671 (2007) > FAHRANTRIEB

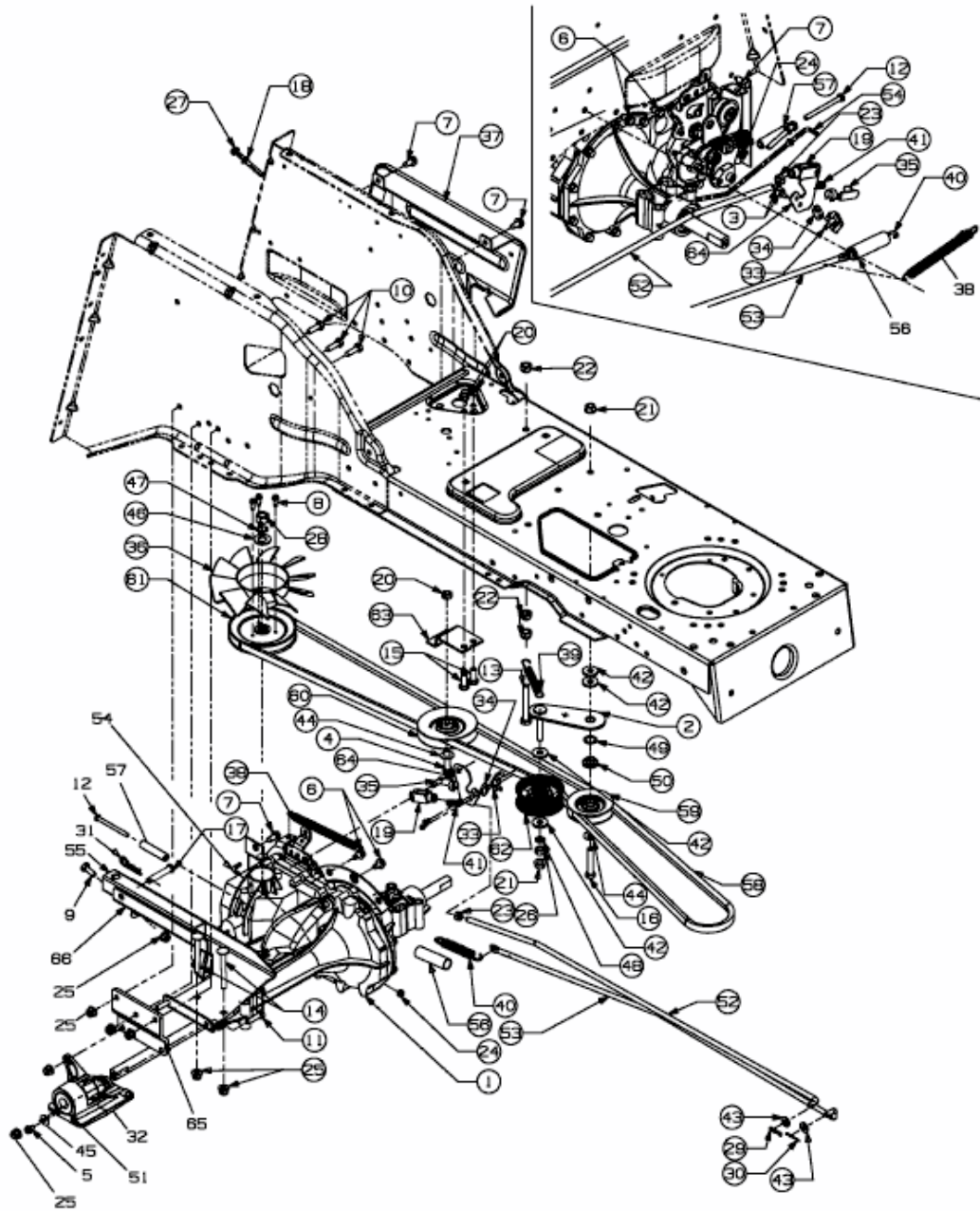

E3-02036B-01