

HE 5150 K > 13CI514E671 (2007) > PEDALE

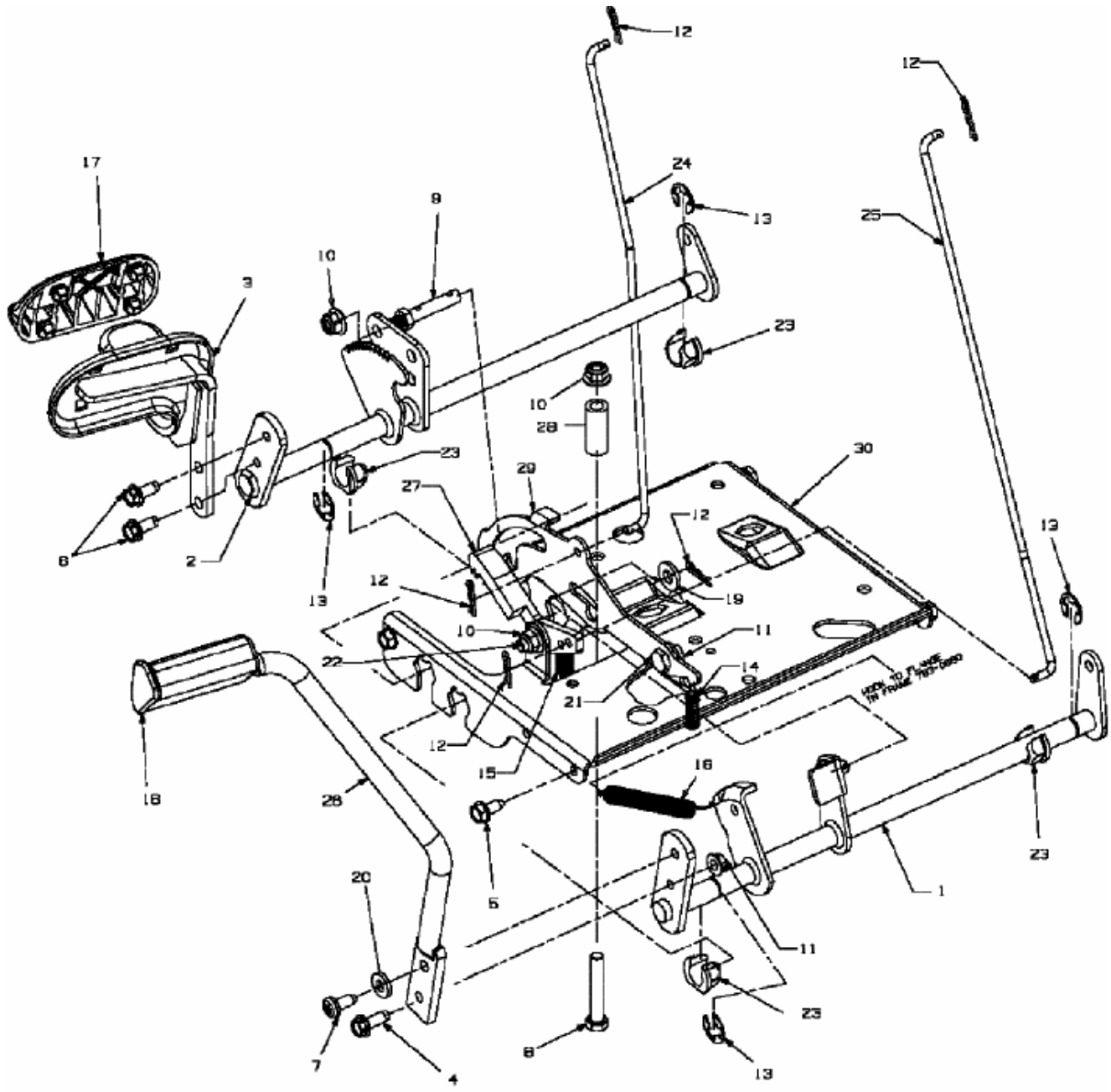

E3-02032B-01