

HE 5150 K > 13CI514E671 (2007) > RAHMEN

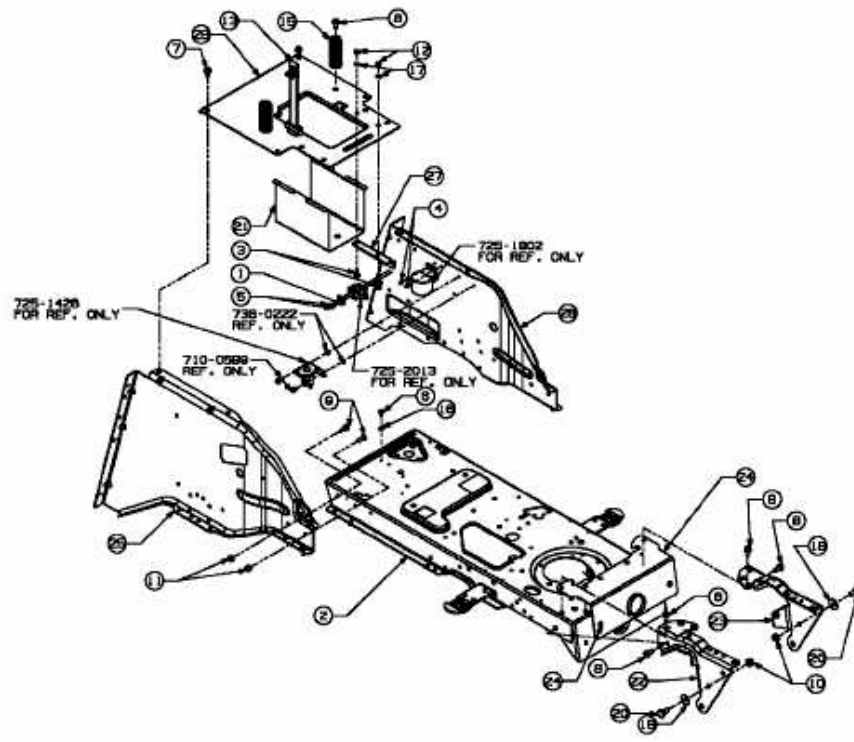

E3-02027A-01