

GLX 92 RALK > 13CI506E690 (2006) > RAHMEN

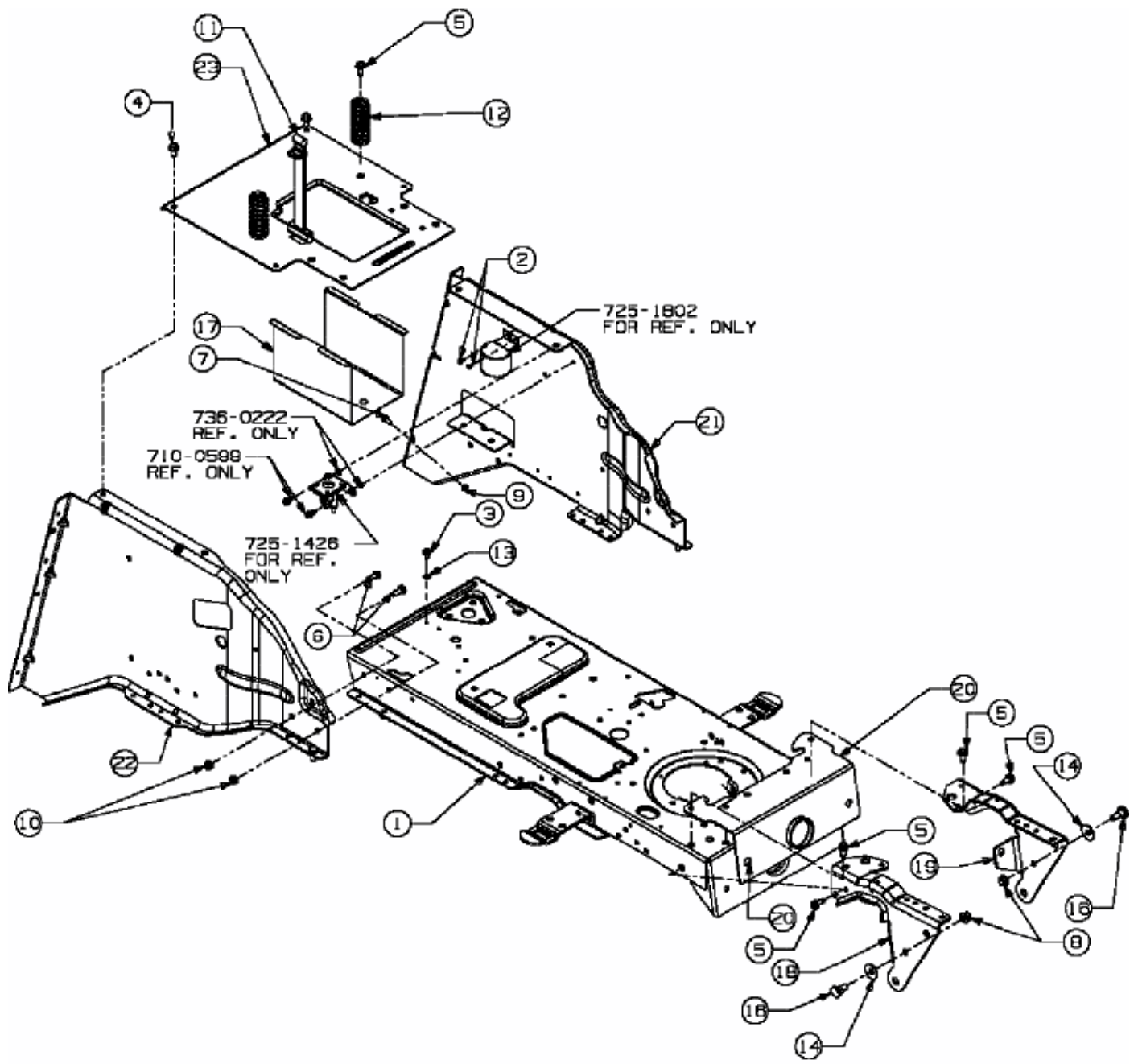

E3-02026A-01