

SMART RF 125 H > 13CH795F676 (2013) > MÄHWERKSEINSCHALTUNG,  
MOTORKEILRIEMENSCHIBE

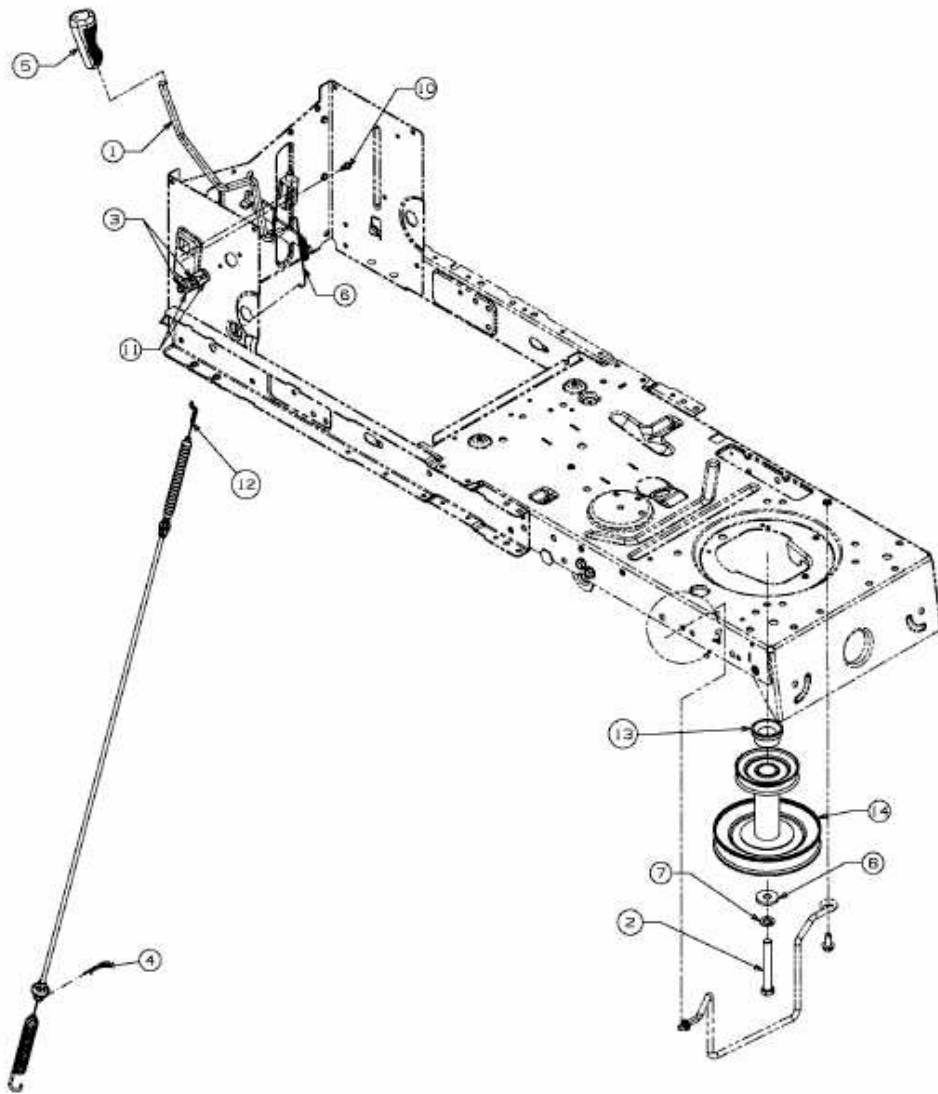

E3-05556C-01