

SMART RF 125 > 13CH765F600 (2014) > GESCHWINDIGKEITSREGELUNG

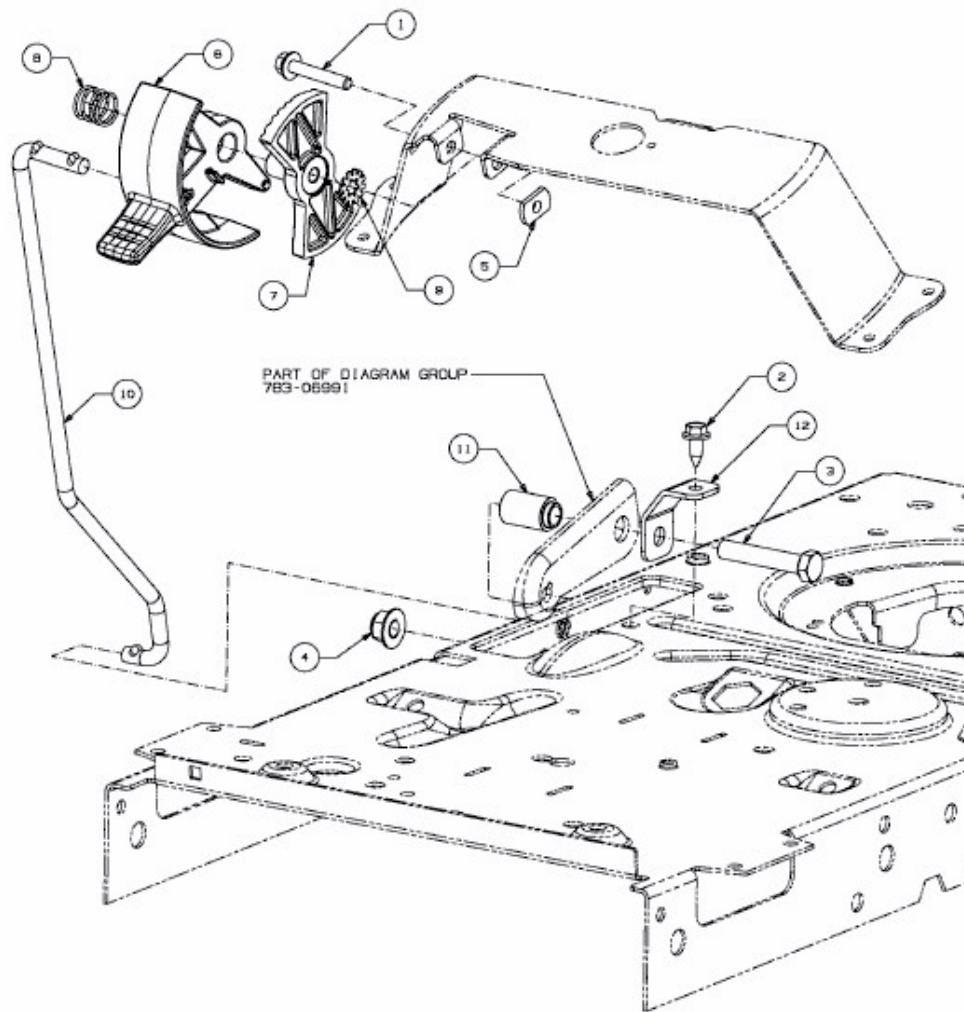

E3-07438B-01