

FW 96 > 13CH761F617 (2014) > GESCHWINDIGKEITSREGELUNG

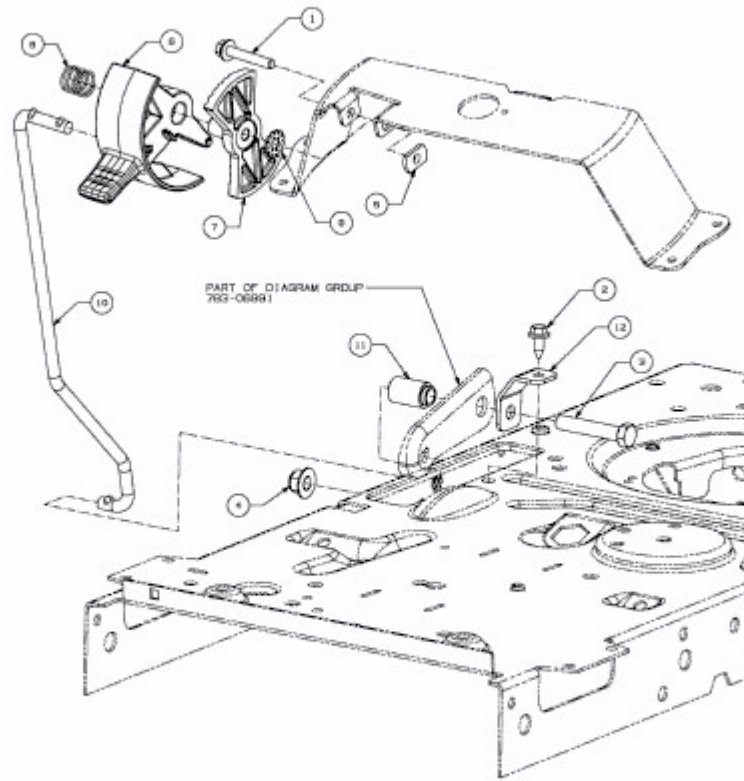

E3-07438B-01