

RS 125/96 B > 13CH761F600 (2012) > GETRIEBE, VARIATOR

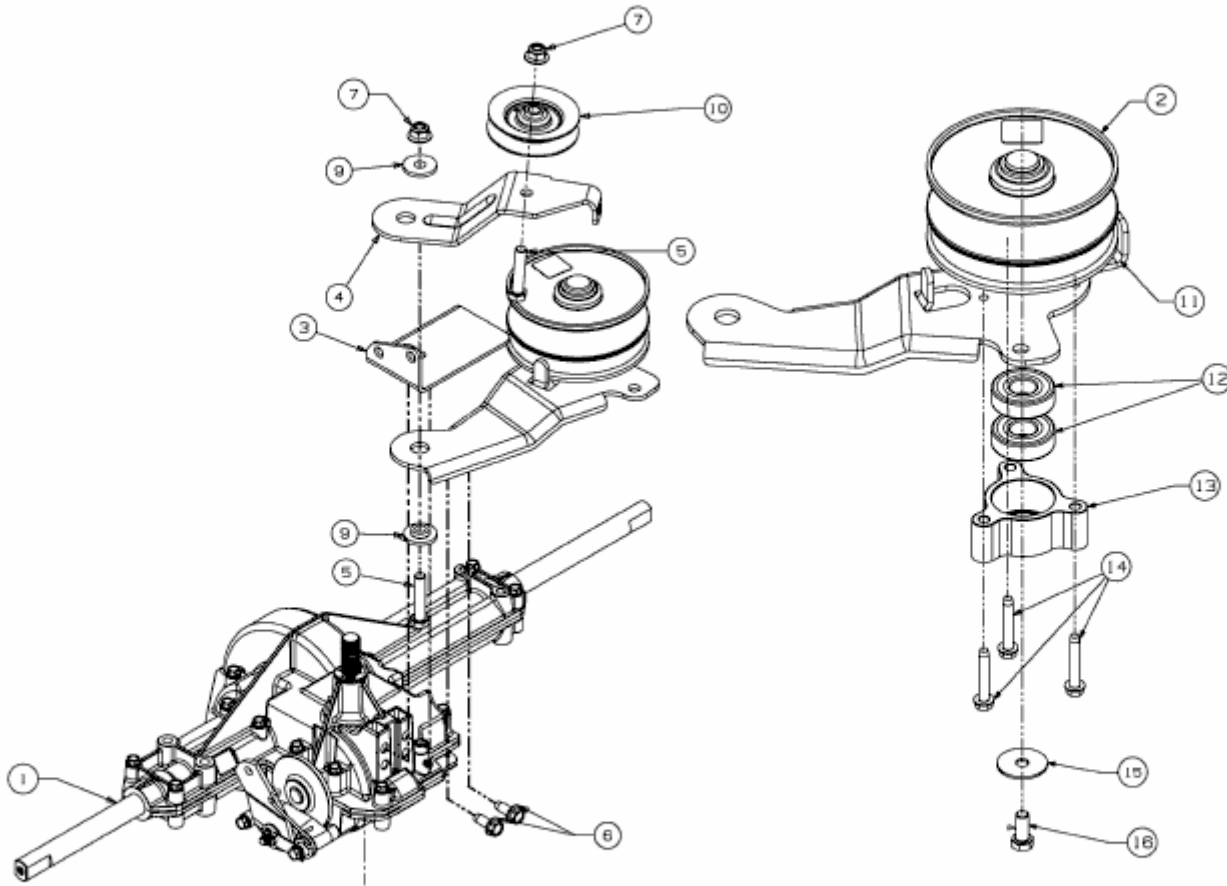

E3-06547A-02