

JLX 60 RA > 13C4054-690 (2010) > ELEKTROTEILE, SCHALTPLAN

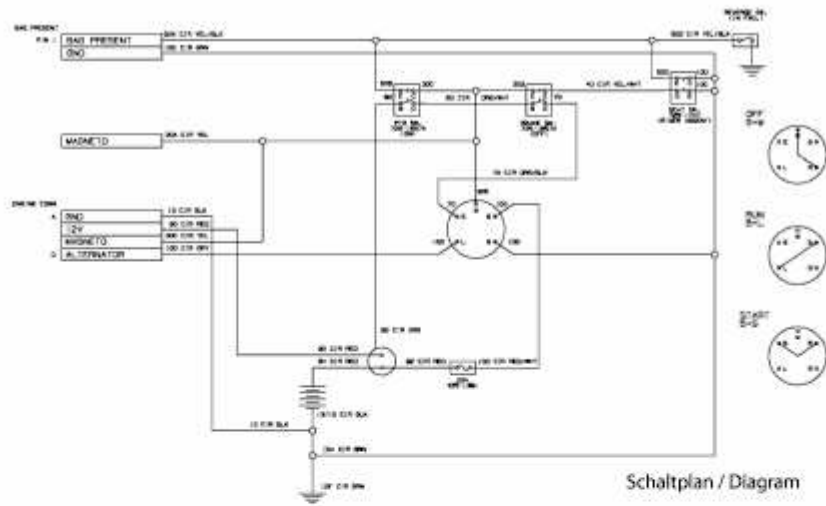

Nicht abgebildet / not shown:

⑥ Kabelbaum / Wire harness

