

MASTERCUT 60 > 13C3054-459 (2012) > RAHMEN

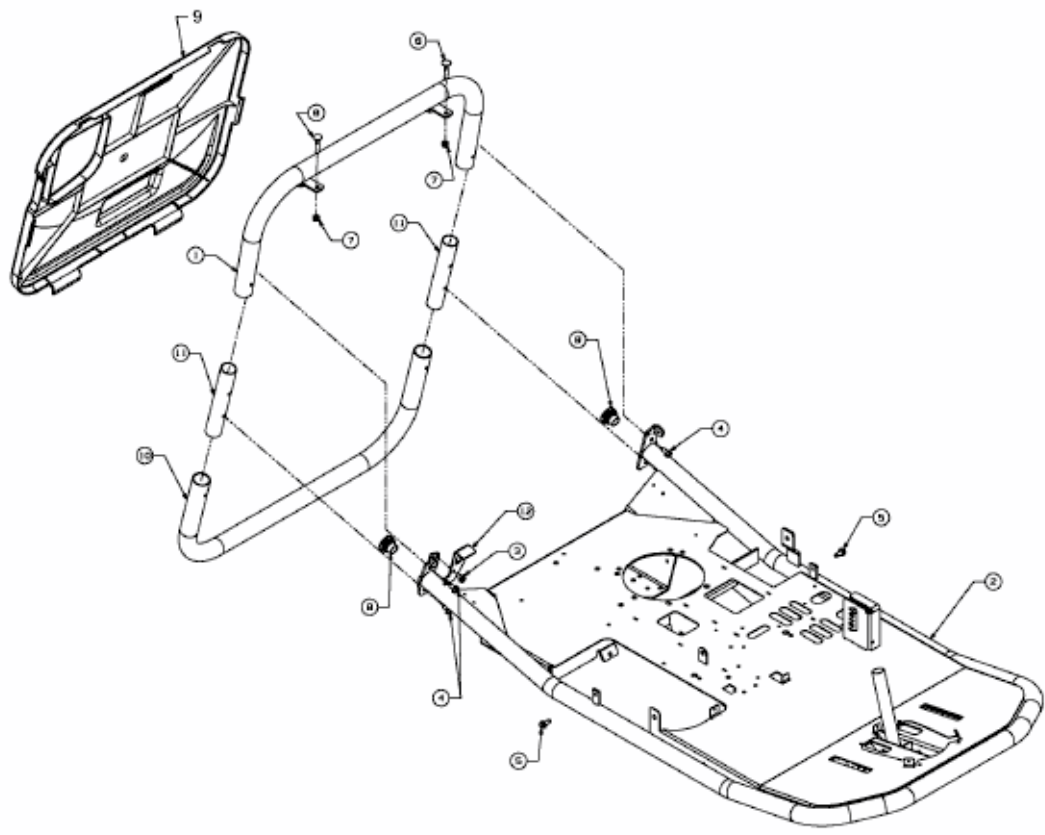

E3-06796A-01