

ab 13.02.2013
from 13.02.2013
à partir du 13.02.2013

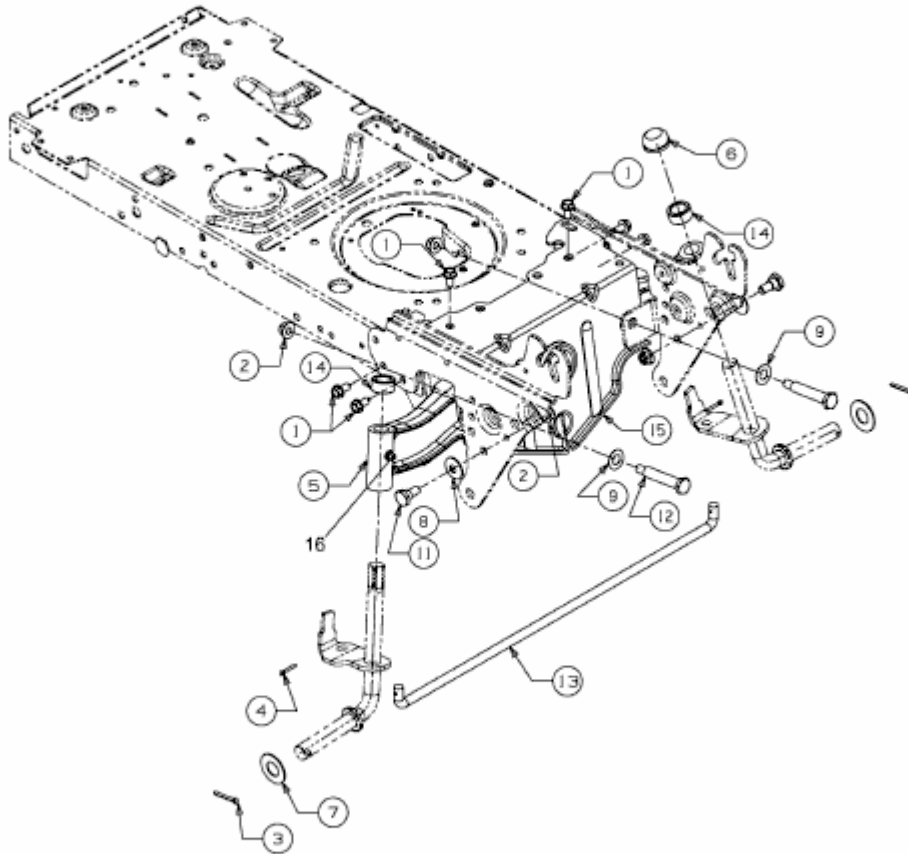

E3-05050B-02