

bis 31.01.2008
to 31.01.2008
jusqu'au 31.01.2008

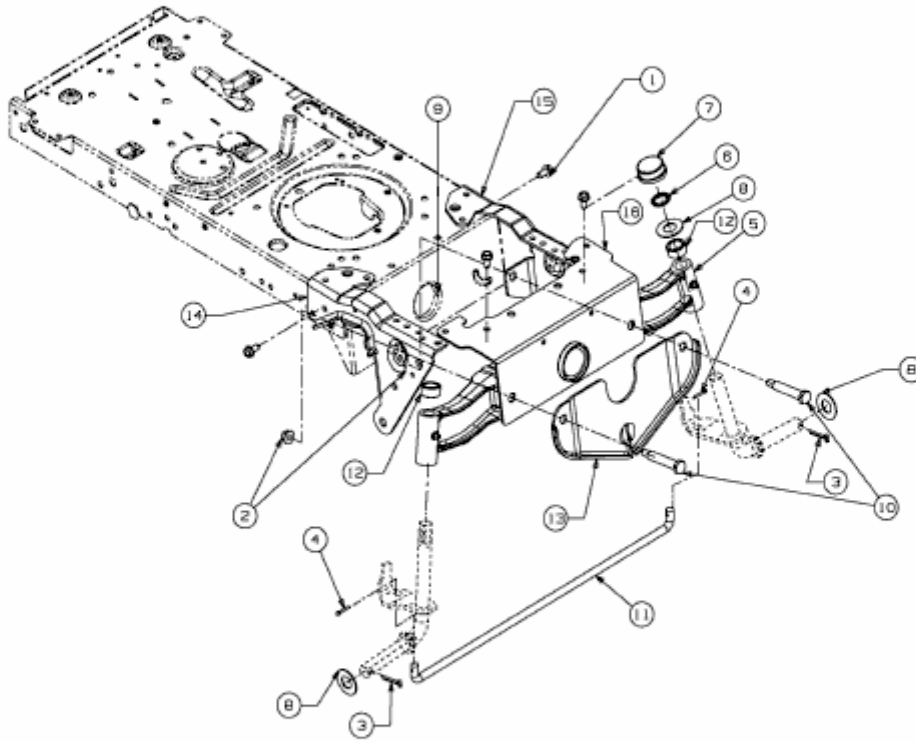

E3-02703B-02