

GLX 105 RH > 13BX516N690 (2007) > ARMATURENBRETT

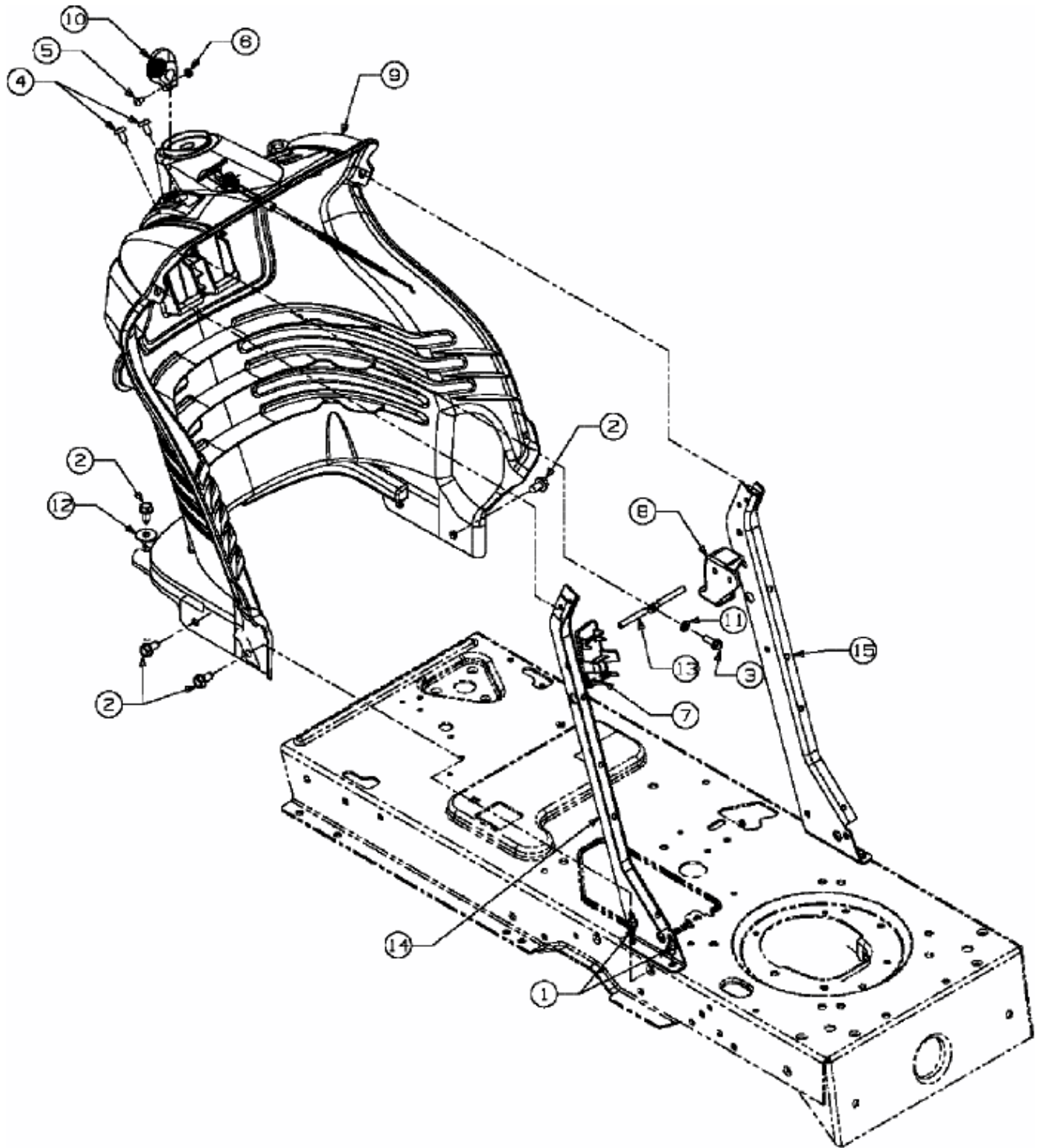

E3-02067B-01