

ab 25.06.2009  
from 25.06.2009  
à partir du 25.06.2009

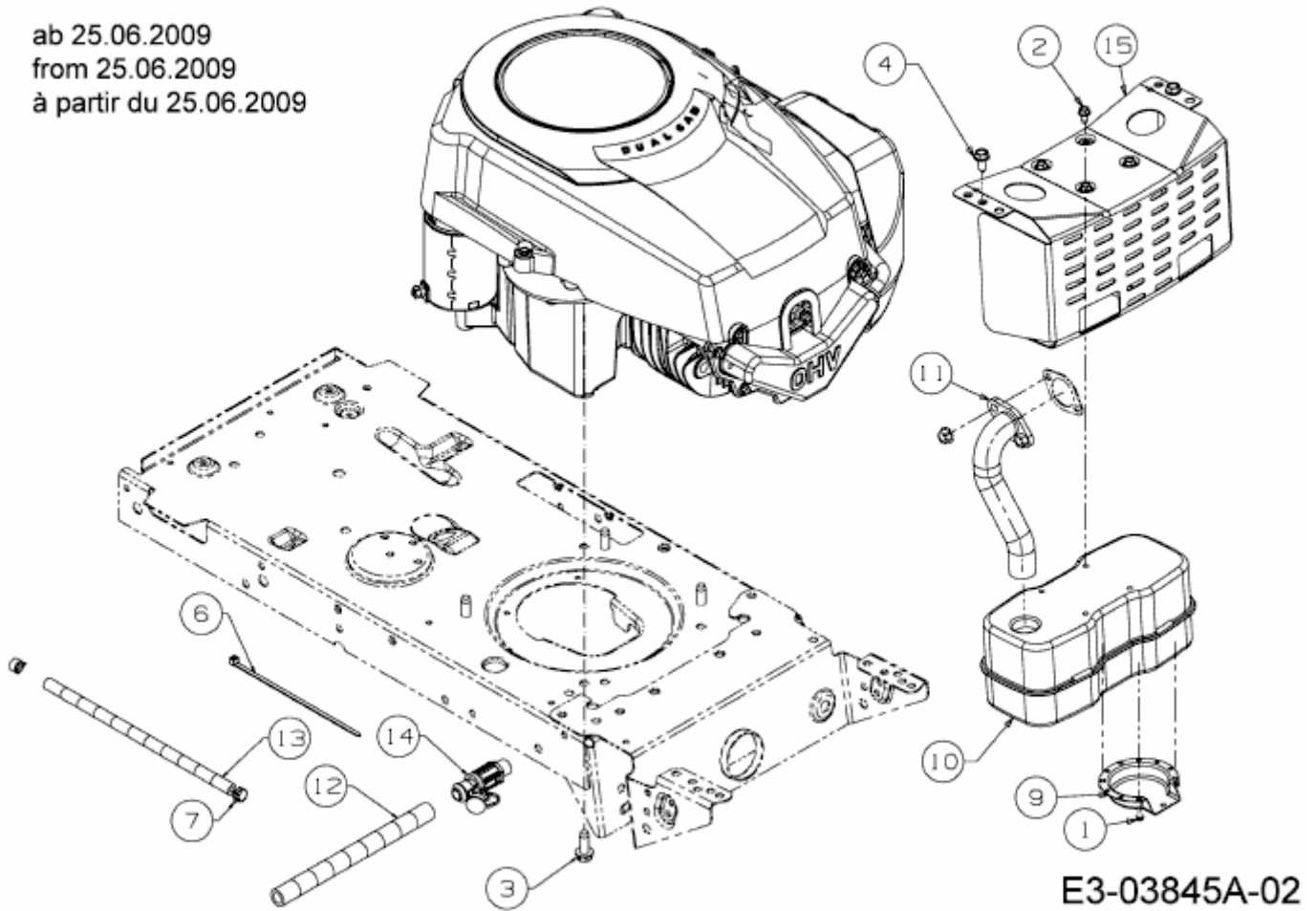

E3-03845A-02