

GG 202 > 13BT763G607 (2012) > GETRIEBE, VARIATOR

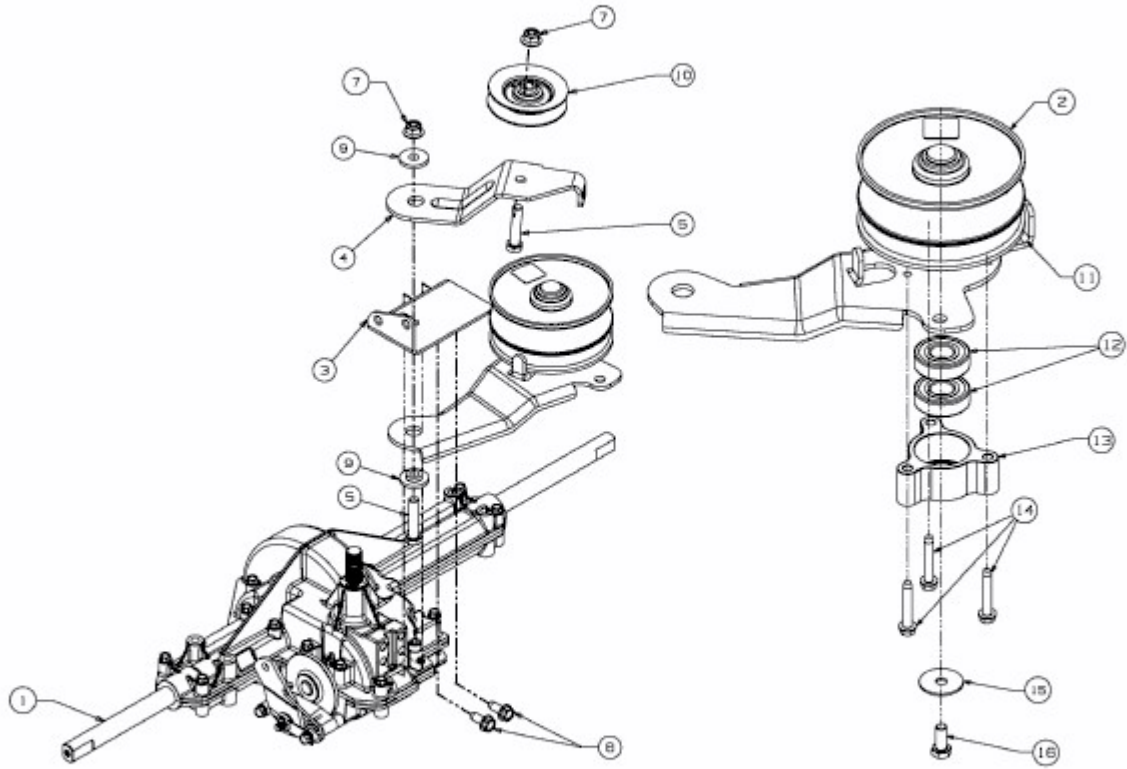

E3-06545B-02