

GLX 92 SHL > 13BT516I690 (2004) > RAHMEN

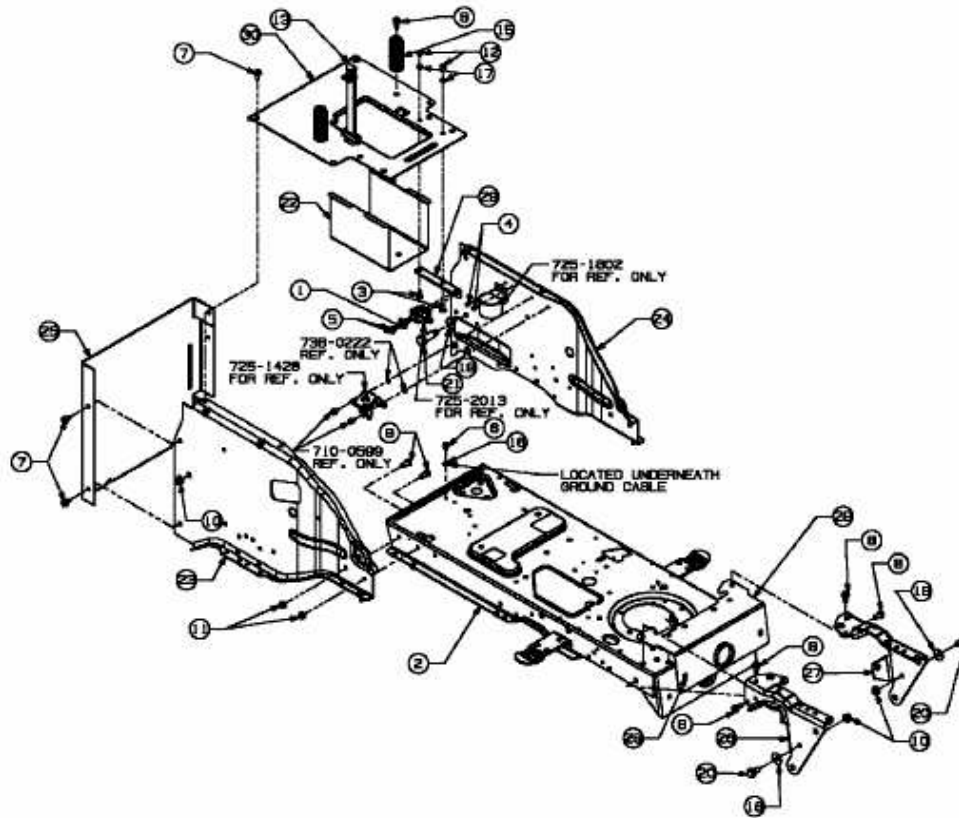

E3-02029A-01