

6

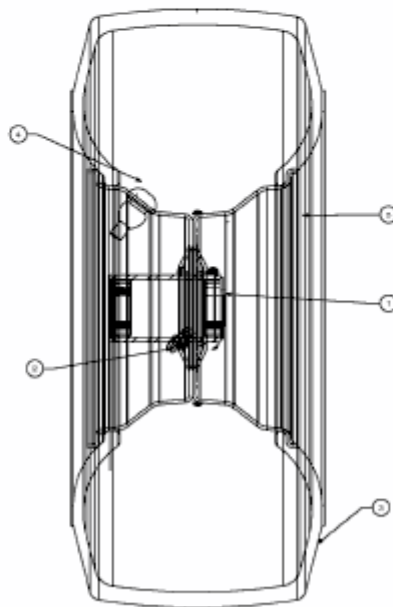

E3-07968A-01