

ab 11.01.2016
from 11.01.2016
à partir du 11.01.2016

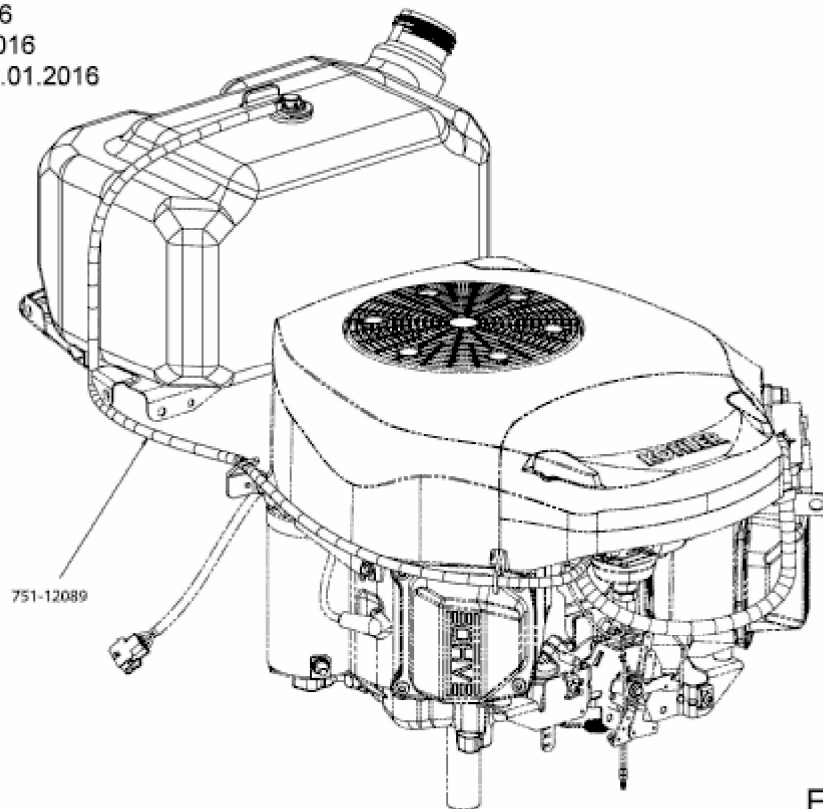

E3-09816A-01