

ab 03.07.2000
 from 03.07.2000
 à partir du 03.07.2000

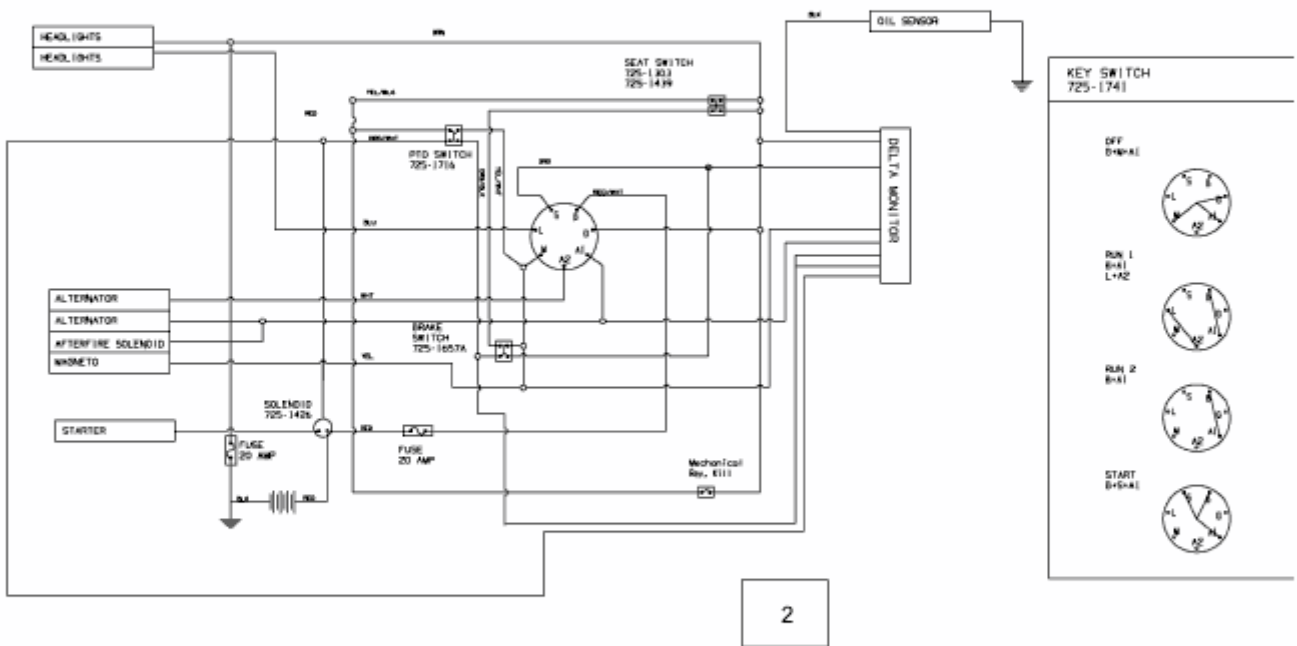

E3-07883A-02