

GLX 92 SHL > 13BP516I690 (2006) > MÄHWERKSAUSHEBUNG

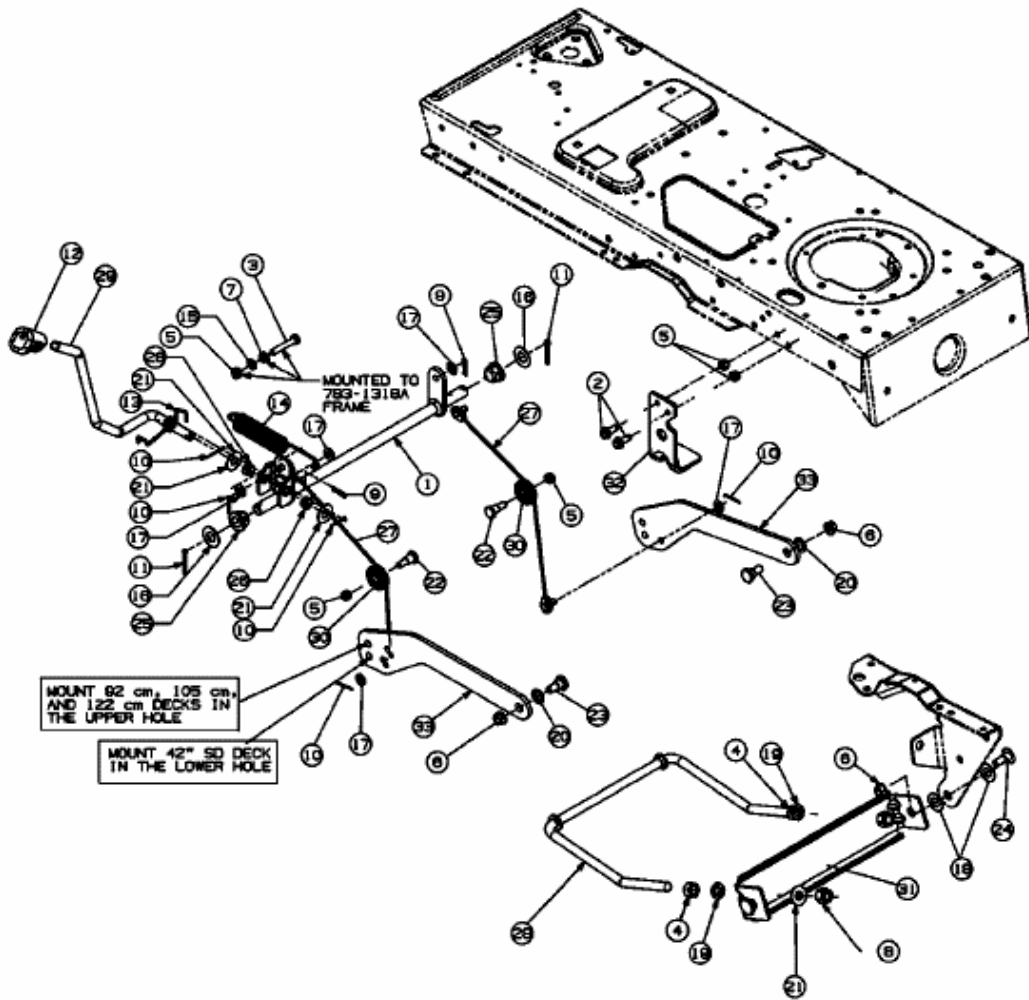

E3-02075A-01