

ab 04.02.2013
from 04.02.2013
à partir du 04.02.2013

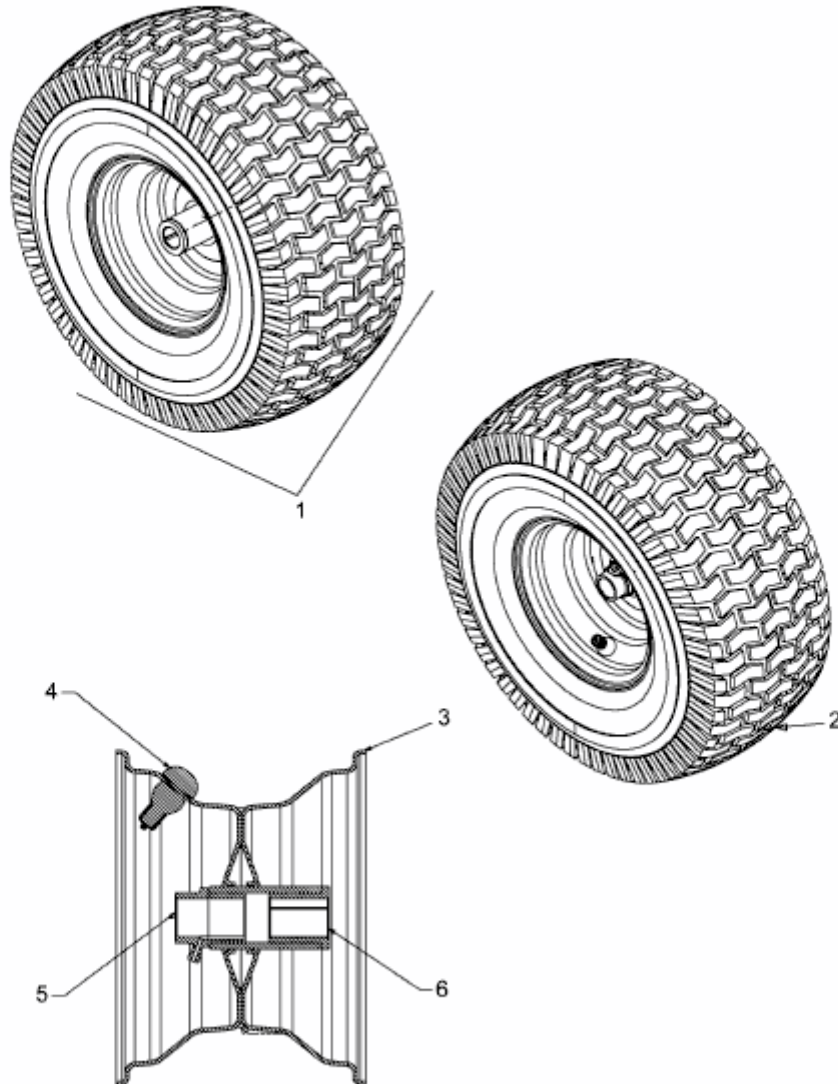

E3-08077A-01