

KROSSER PLUS 105/17,5 H > 13BN49KN436 (2011) > MOTORKEILRIEMENSCHLEIBE

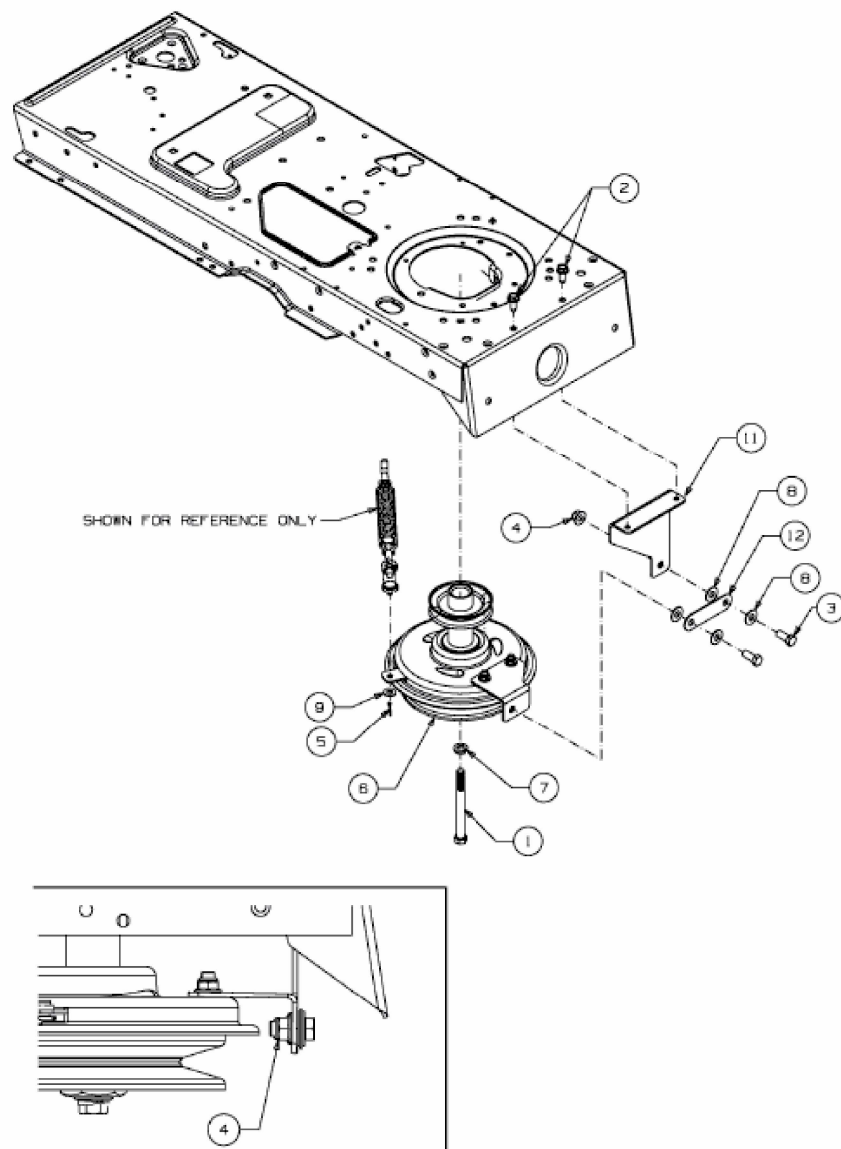

E3-05296A-01