

---

RANGER 1 (155/96 T) > 13BM778F661 (2012) > LENKRAD MIT LOGO

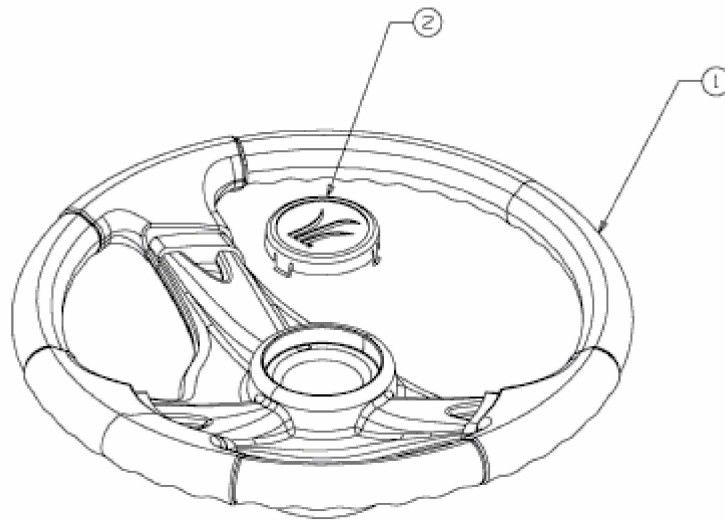

E3-02014A-01