

AM 1201 > 13BH663G619 (2004) > GETRIEBE

618-0163B

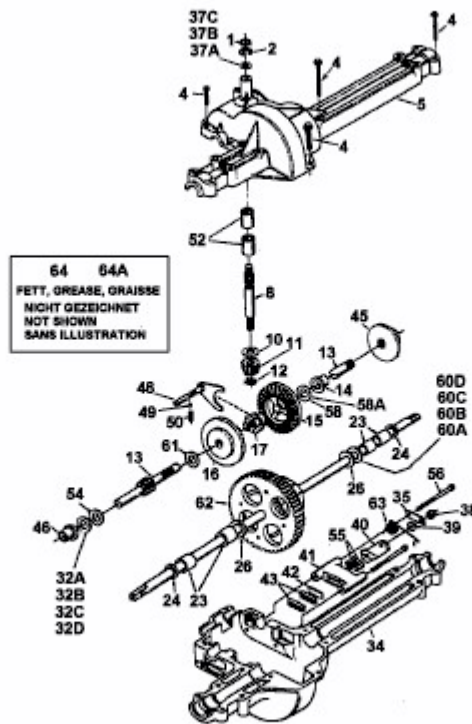

E4-00794A