

ab 01.02.2014  
from 01.02.2014  
à partir du 01.02.2014

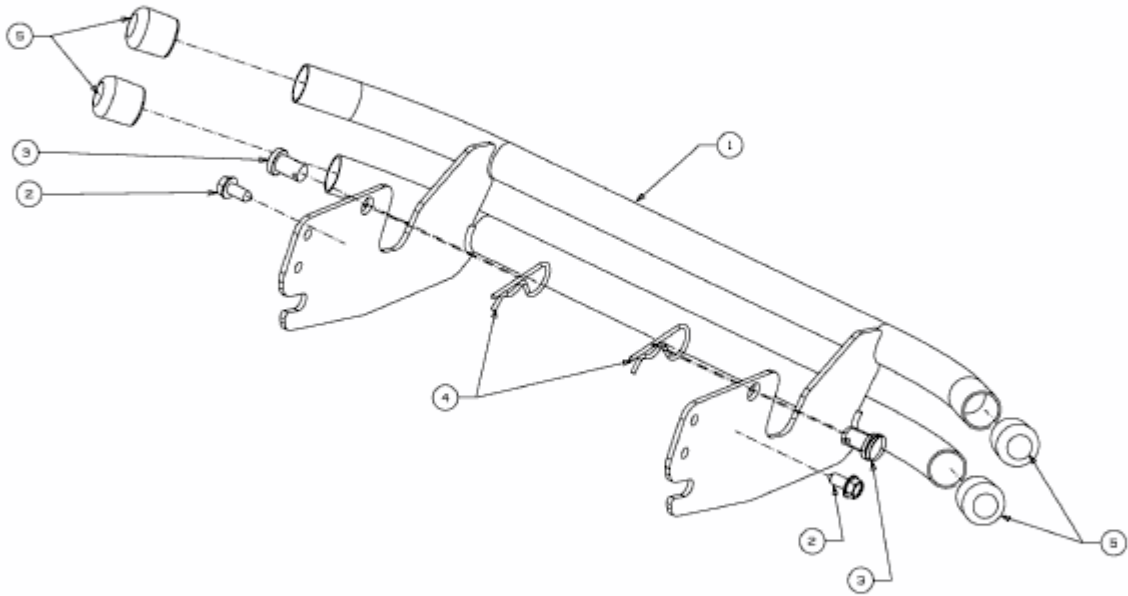

E3-03979C-02