

ELX 107 SHL-K > 13BG91GG690 (2012) > ELEKTROTEILE, SCHALTPLAN

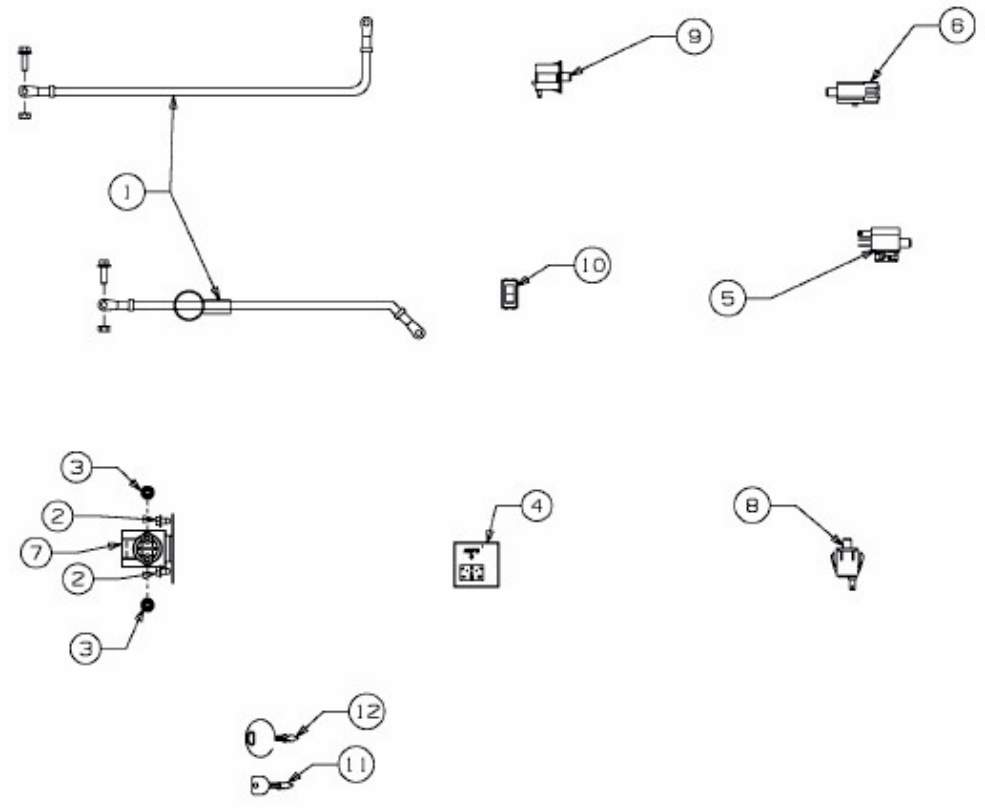
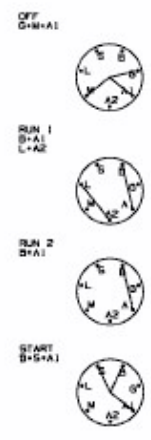
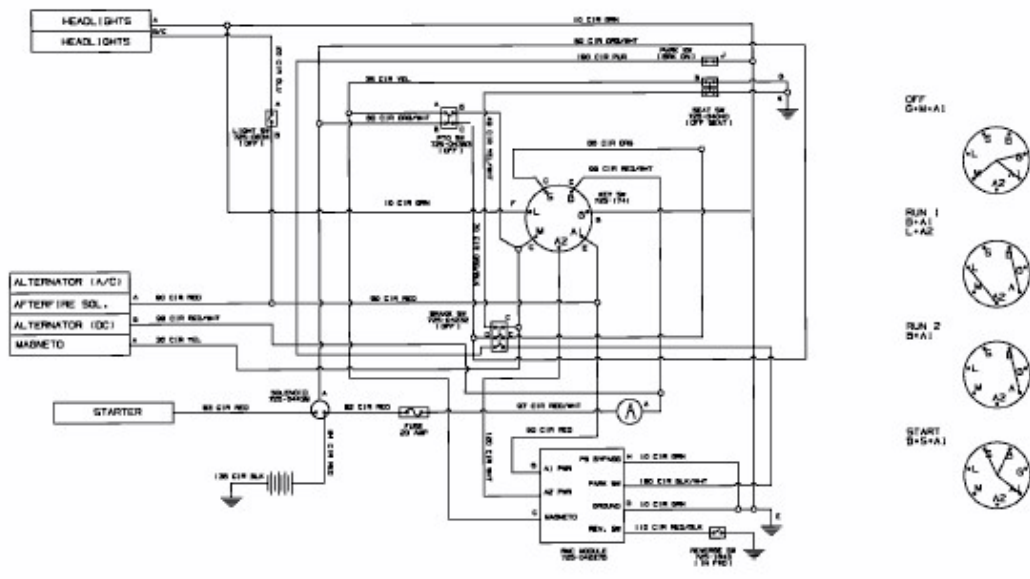

E3-04564B-01