

ELX 107 SHL-K > 13BG91GG690 (2011) > DEFLEKTOR AB 02.10.2001

ab 02.10.2001
from 02.10.2001
à partir du 02.10.2001

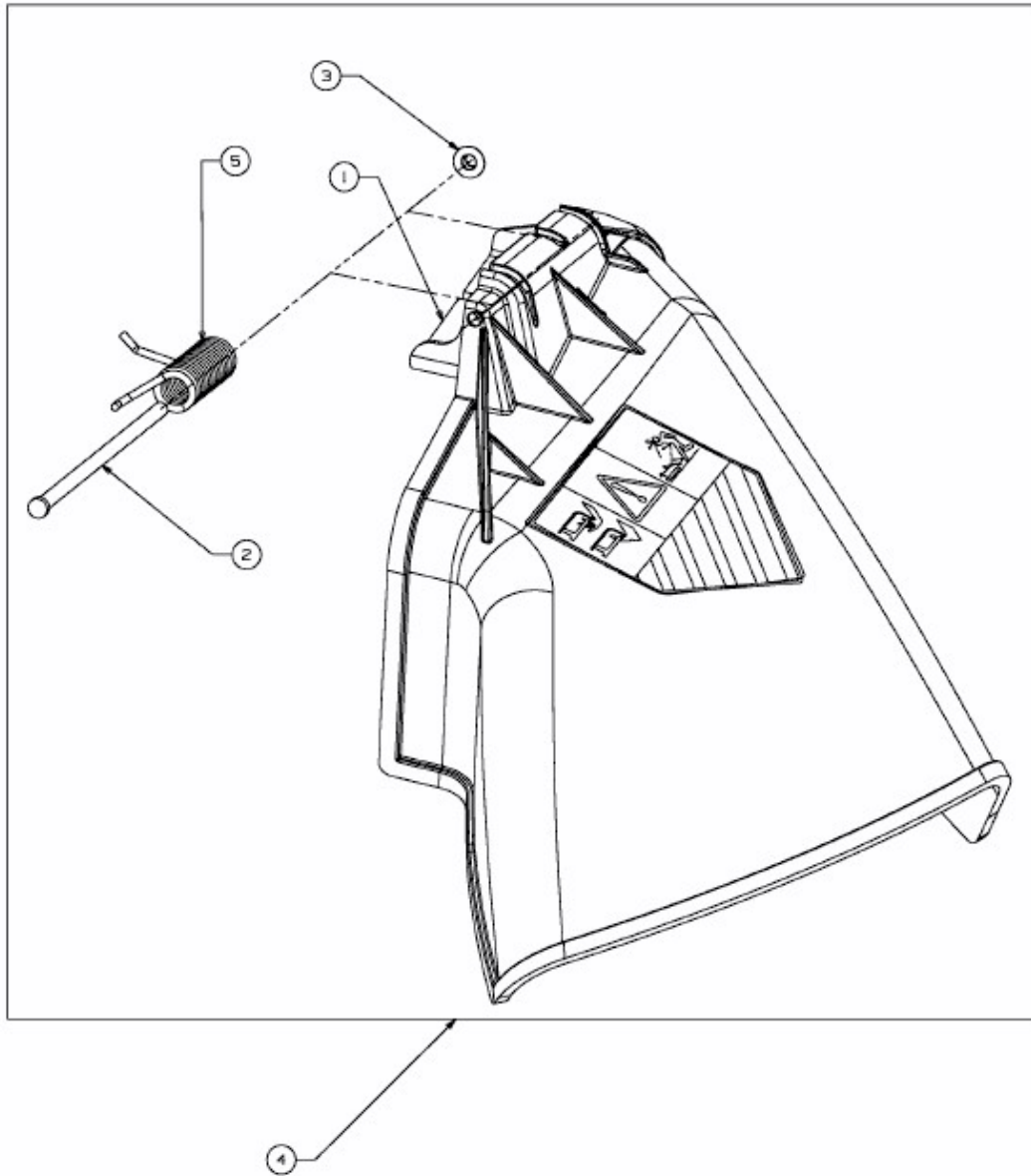

E3-04592A-01