

GLX 105 RALK > 13BG50GN690 (2009) > MOTORKEILRIEMENSCHLEIBE

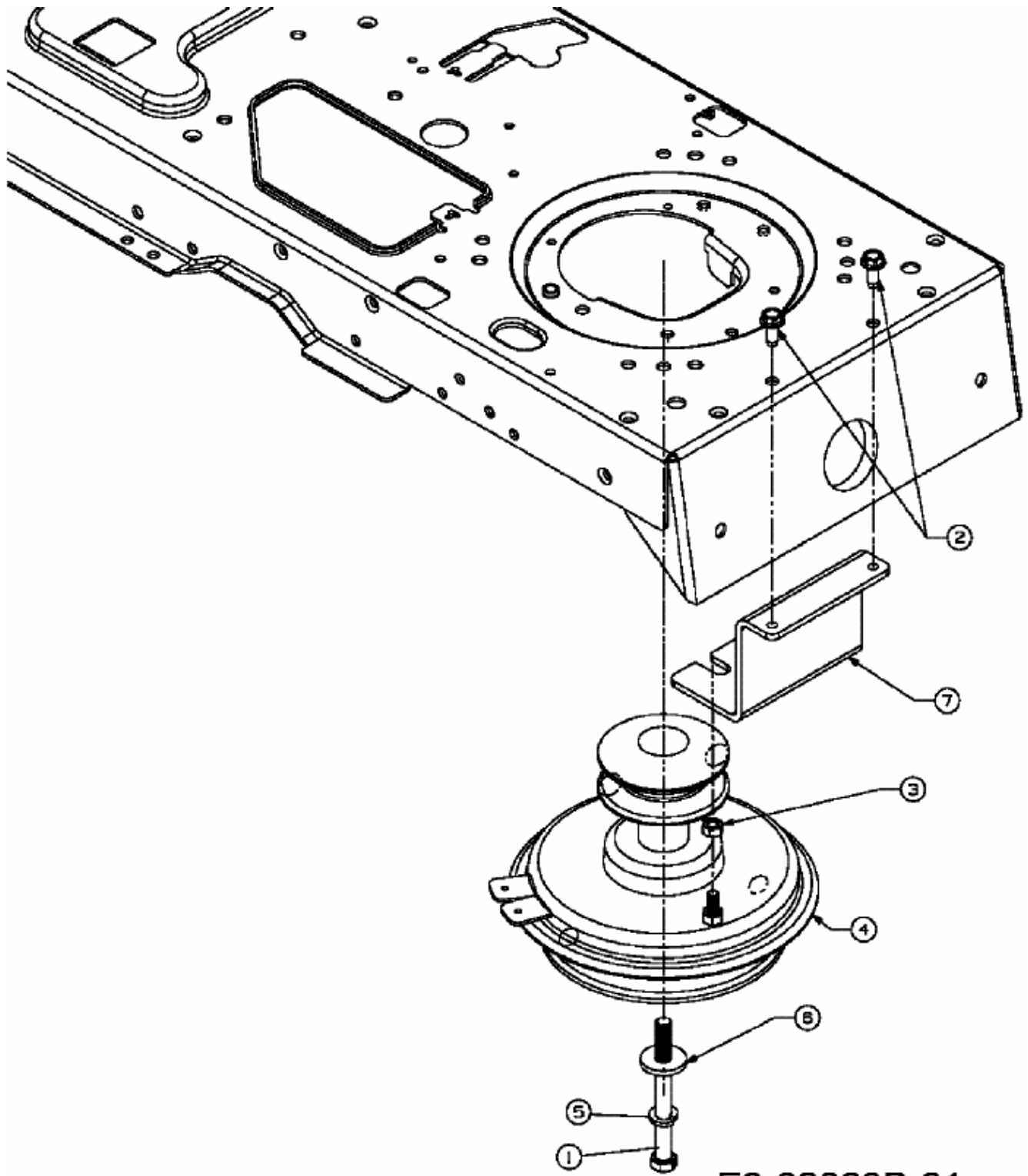

E3-02063B-01