

GLX 105 RALK > 13BG50GN690 (2009) > MESSERSPINDEL 618-04657

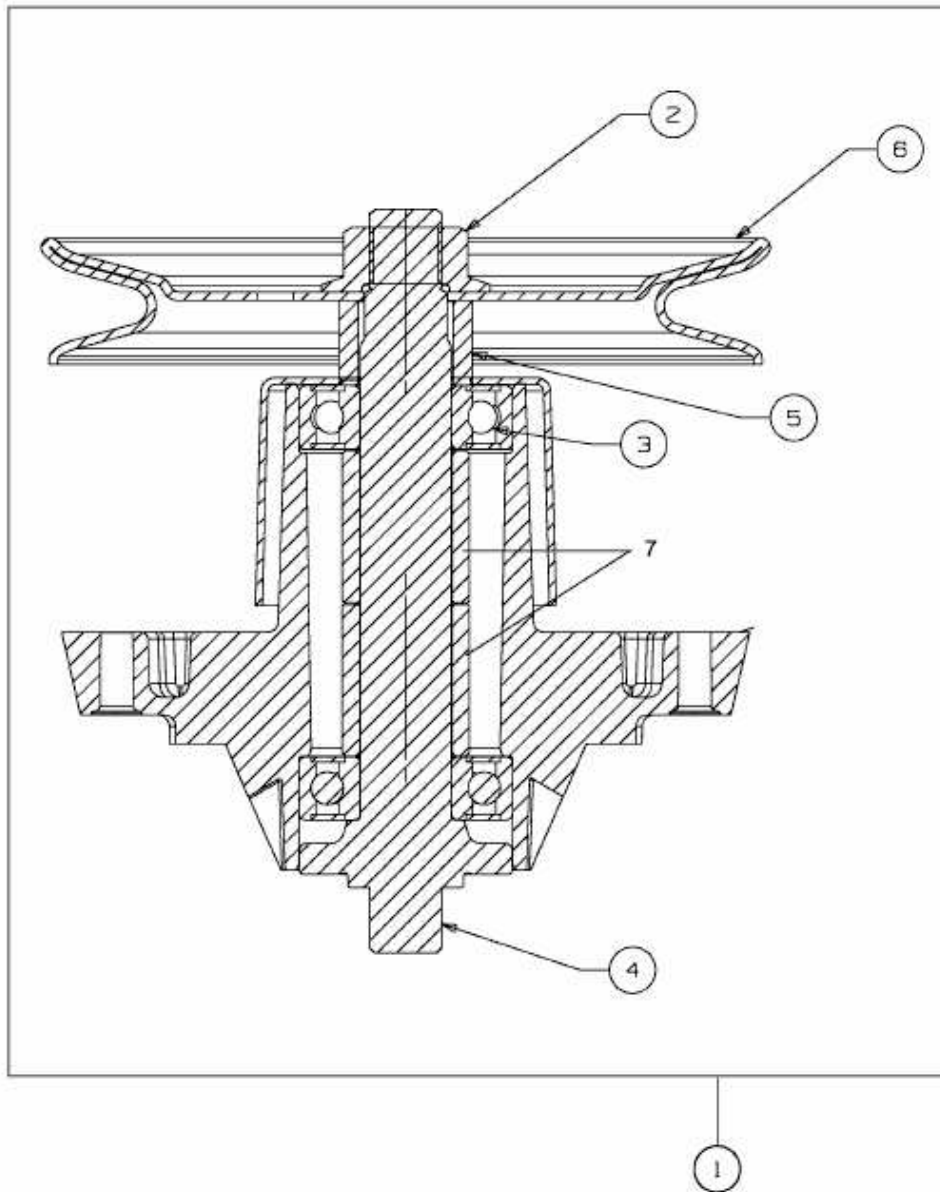

E3-03996A-01