

GLX 105 RALK > 13BG50GN690 (2009) > HIGH LIFT MESSER

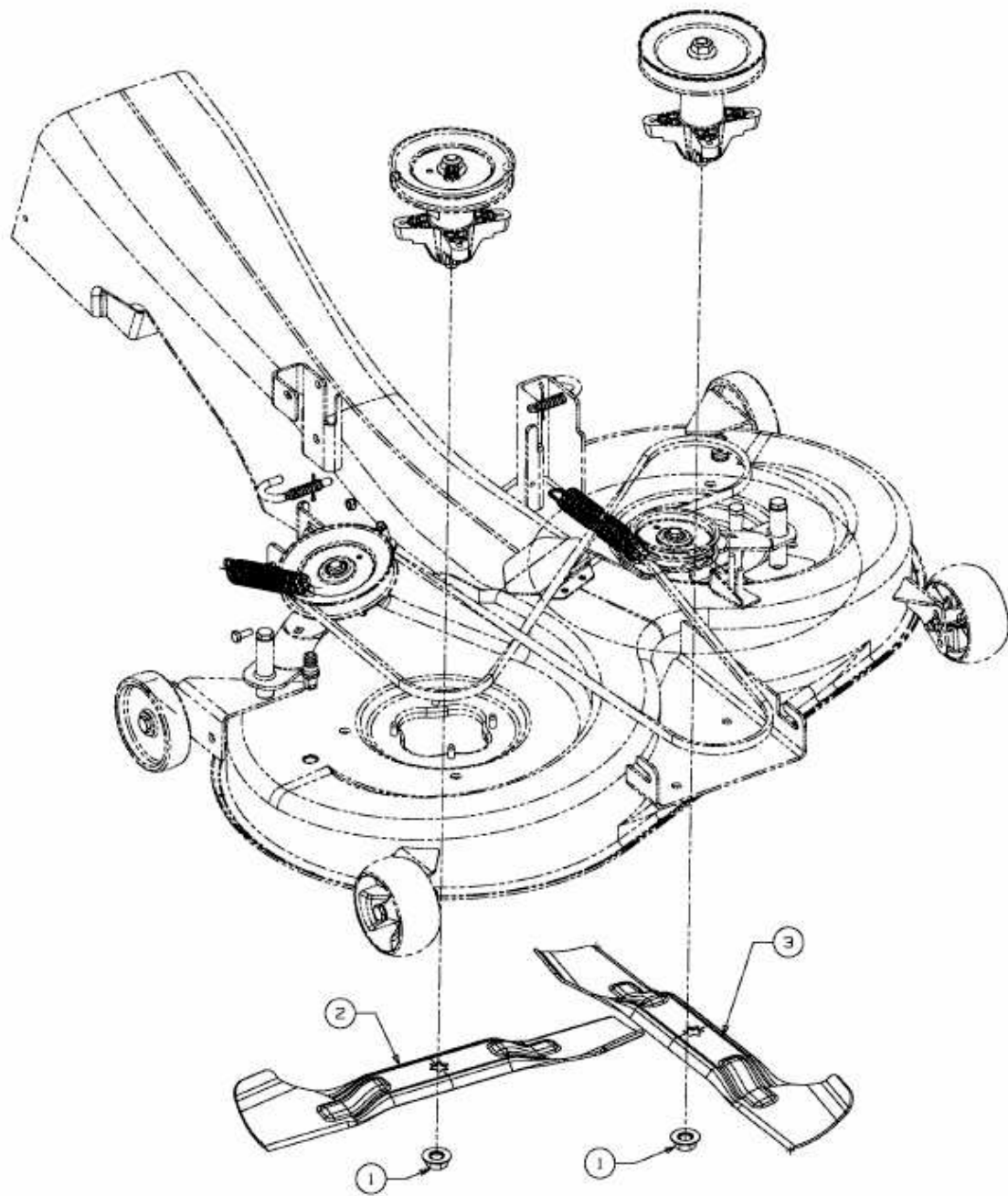

E3-03077A-01