

GLX 105 RALK > 13BG50GN690 (2009) > MÄHWERKSAUSHEBUNG

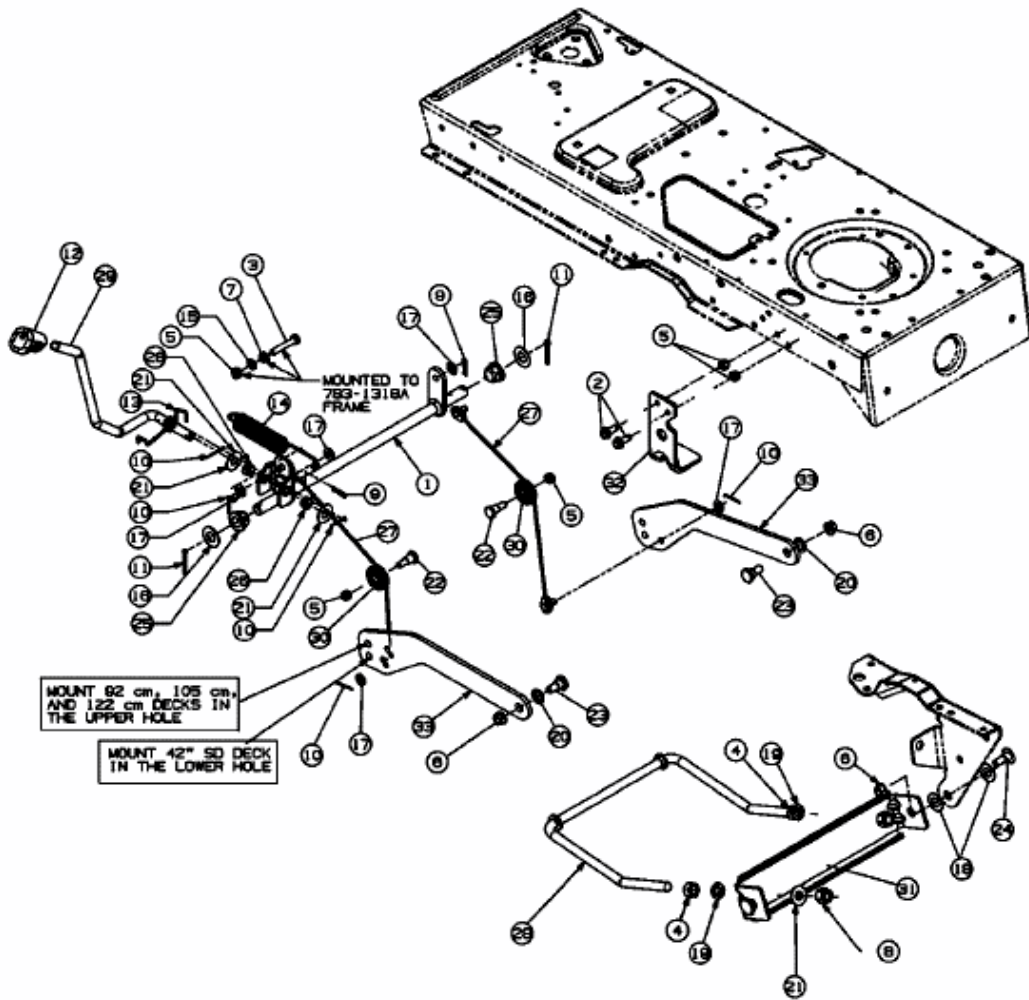

E3-02075A-01