

GLX 105 RALK > 13BG50GN690 (2009) > MÄHWERKSEINSCHALTUNG

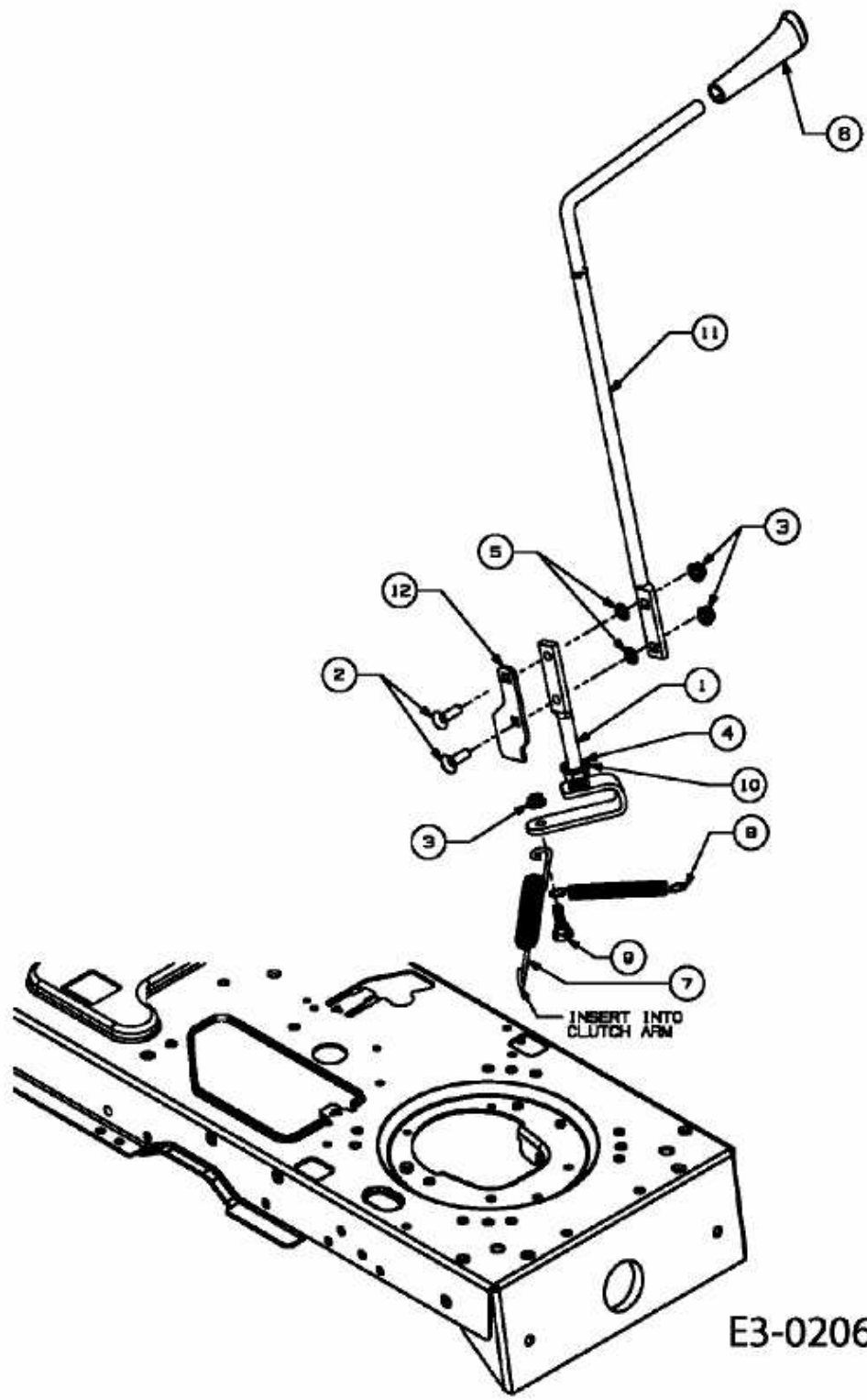

E3-02062B-01