

FORMULA 107 H > 13BA519G637 (2004) > ARMATURENBRETT

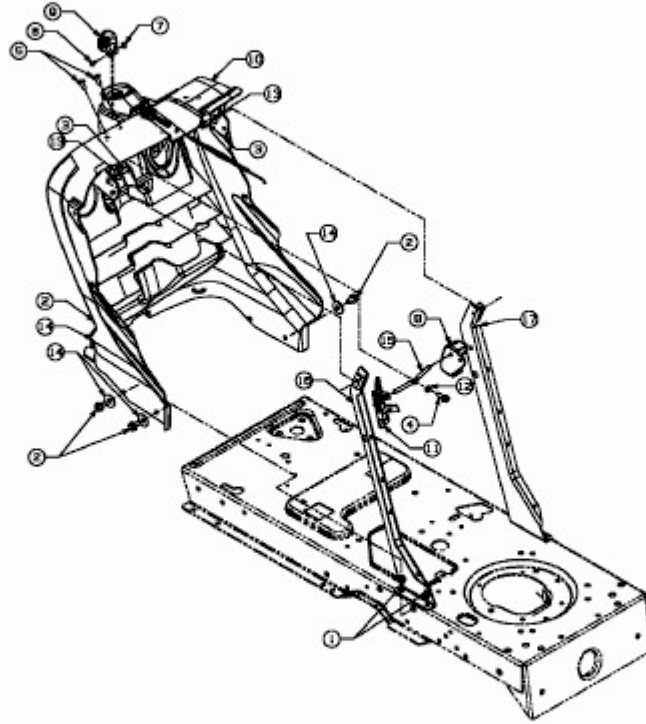

E3-02021A-01