

FORMULA 107 H > 13BA519G637 (2004) > MOTORKEILRIEMENSCHLEIBE

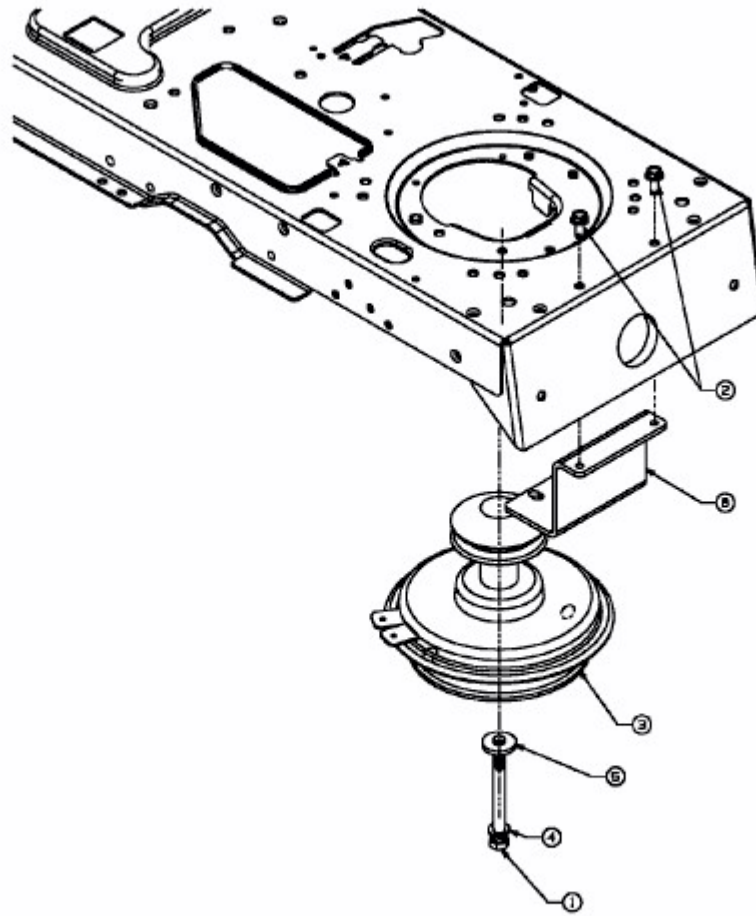

E3-02064A-01