

FORMULA 107 H > 13BA519G637 (2004) > SITZTRÄGER

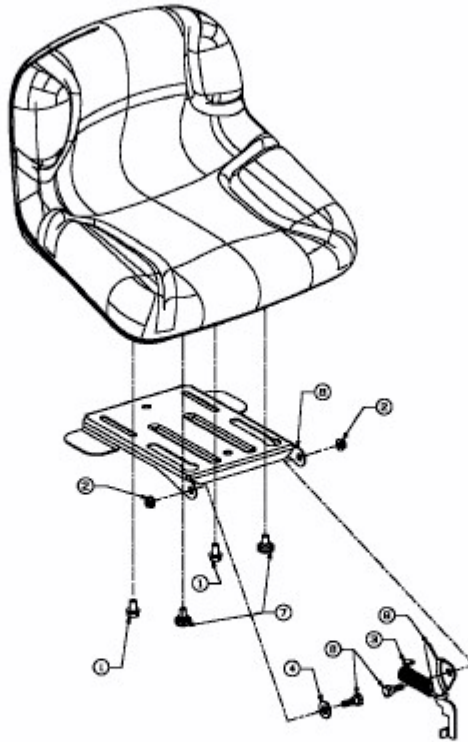

E3-02012A-01