

FORMULA 107 H > 13BA519G637 (2003) > LENKRAD

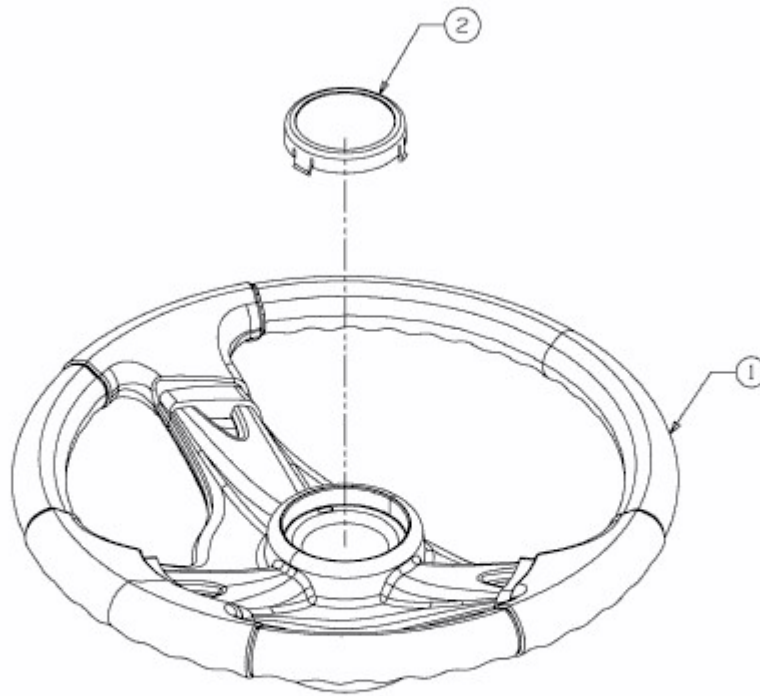

E3-02015A-01