

SE 135 A > 13BA508E678 (2003) > FAHRANTRIEB BIS 31.12.2002

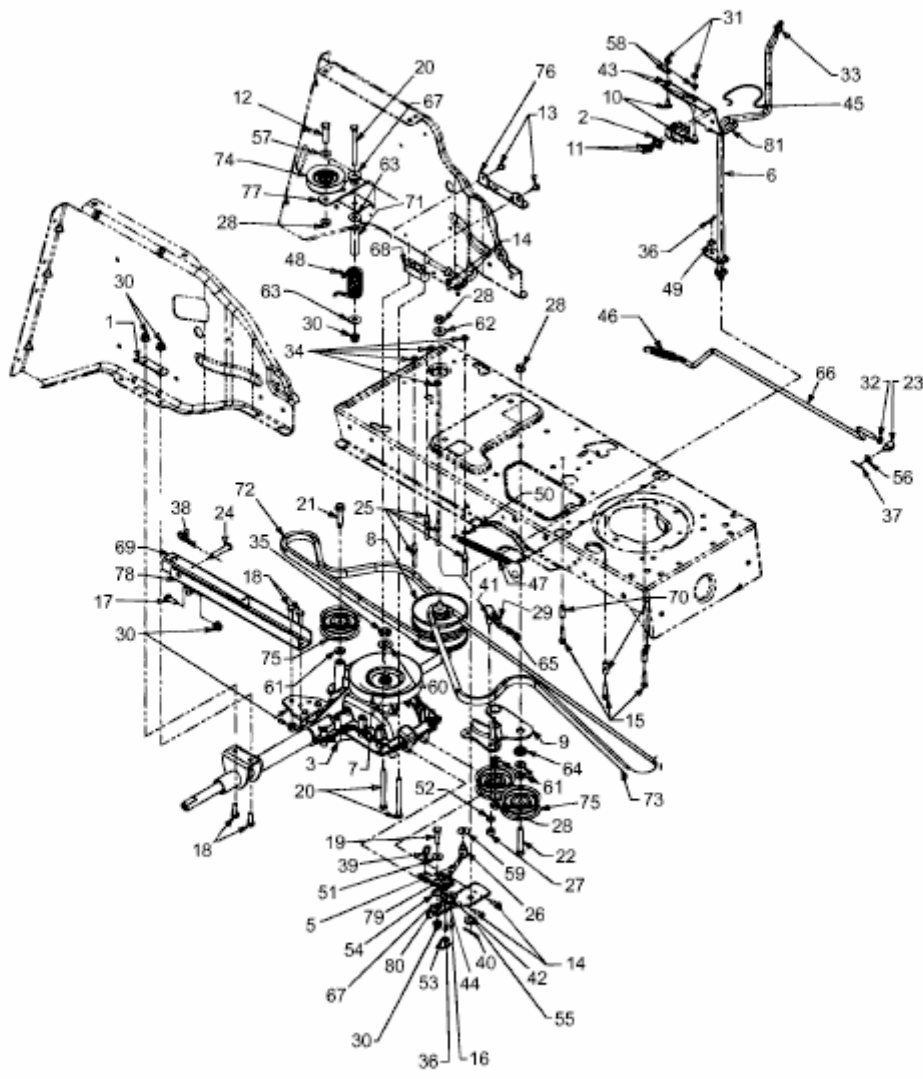

E3-07960A-01