

SE 135 A > 13BA508E678 (2003) > MÄHWERKSEINSCHALTUNG

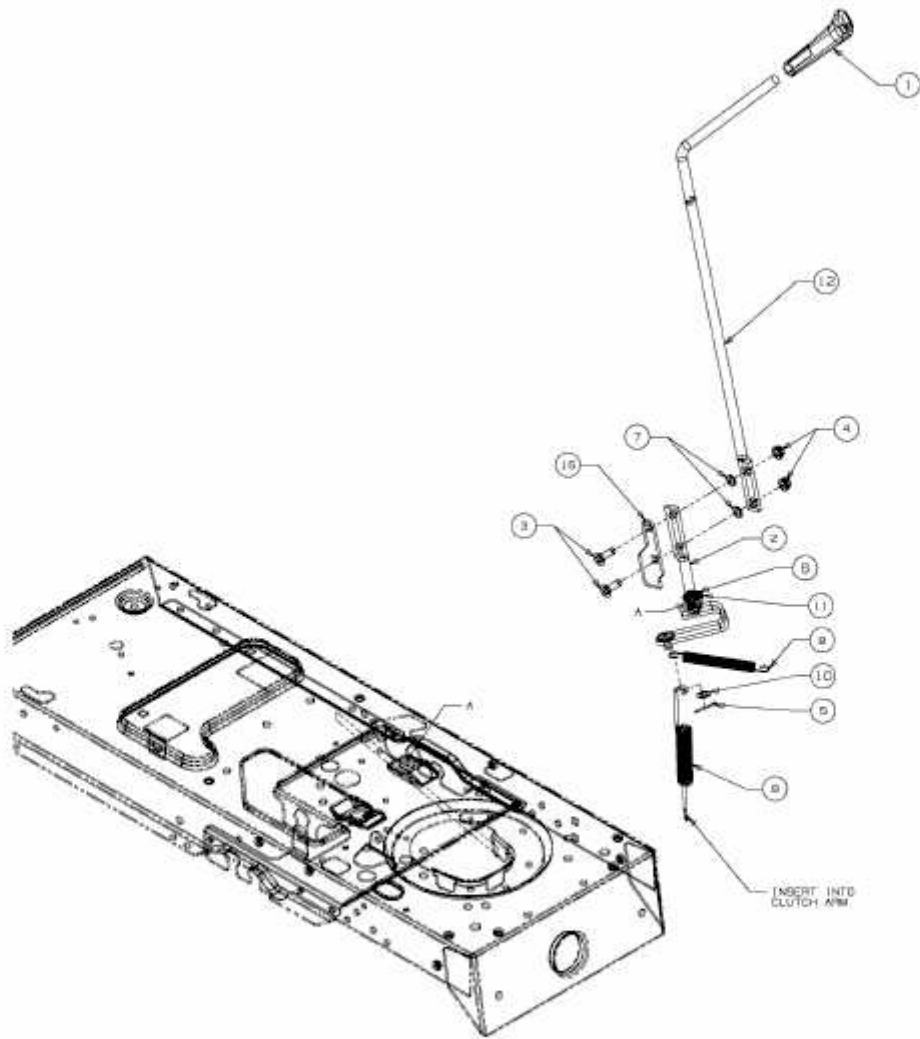

E3-01676A-02