

ab 01.01.2003  
from 01.01.2003  
à partir du 01.01.2003

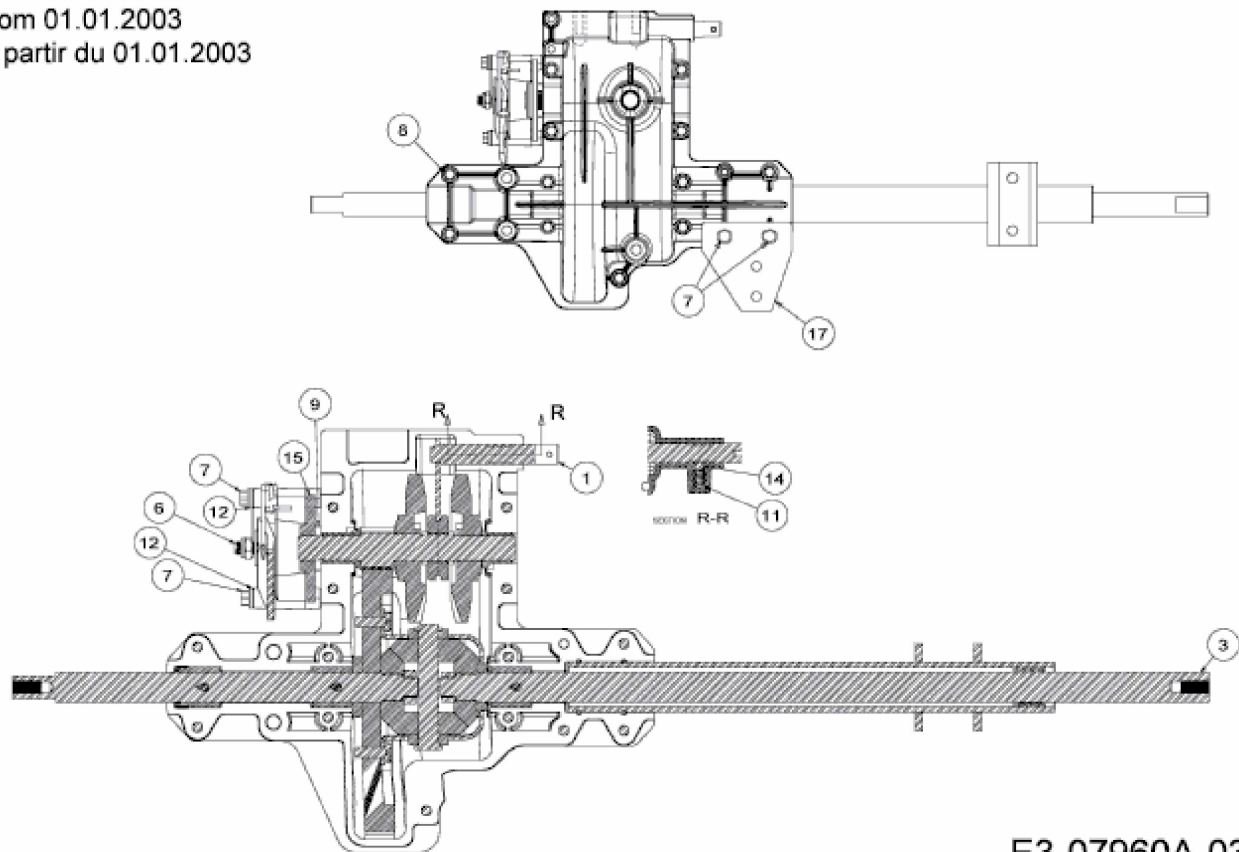

E3-07960A-03