

ab 01.01.2003
from 01.01.2003
à partir du 01.01.2003

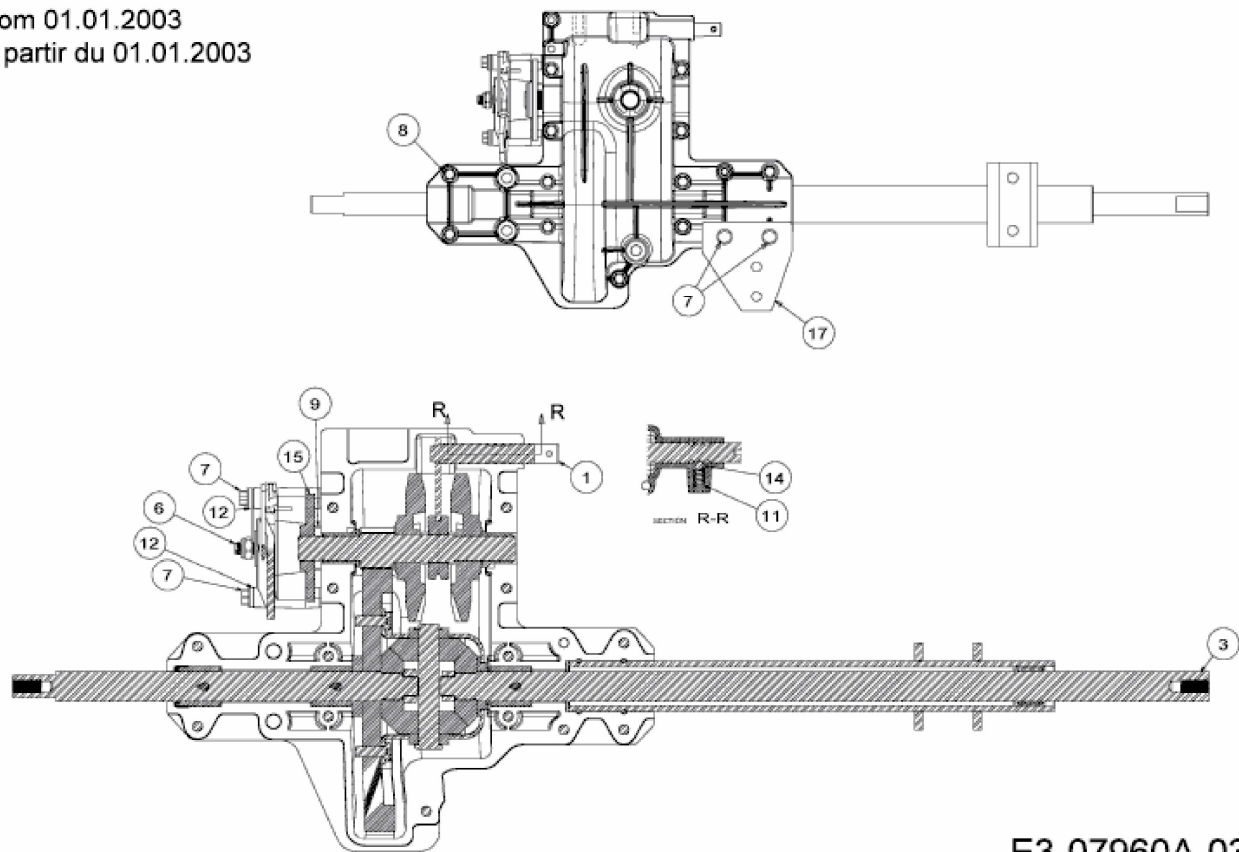

E3-07960A-03