

TF 4135 > 13BA474F643 (2002) > MÄHWERKSAUSHEBUNG

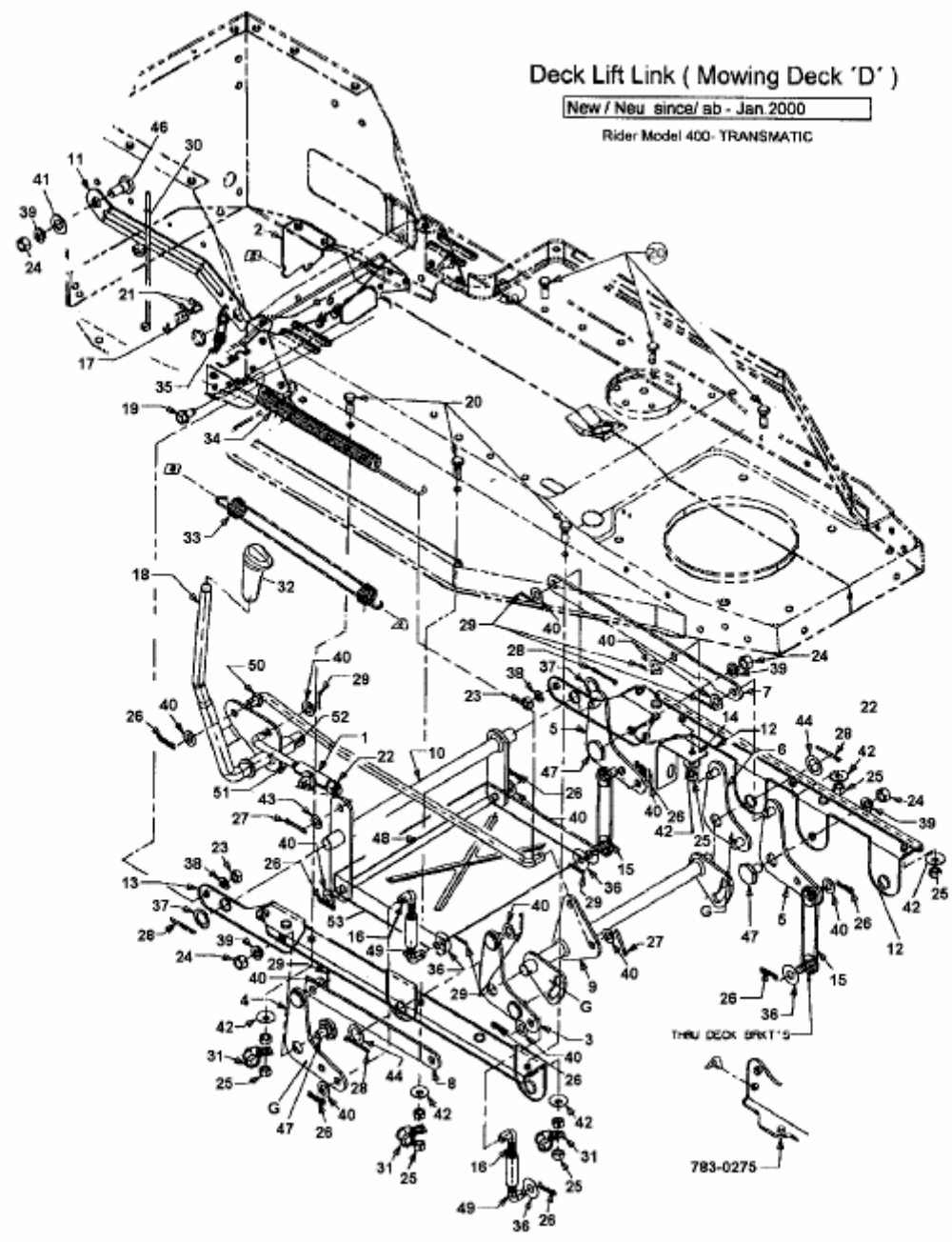

fsg

E3-01591A-01