

TF 4135 > 13BA474F643 (2002) > FAHRANTRIEB, MOTORKEILRIEMENSCHLEIBE, PEDAL, RÄDER HINTEN

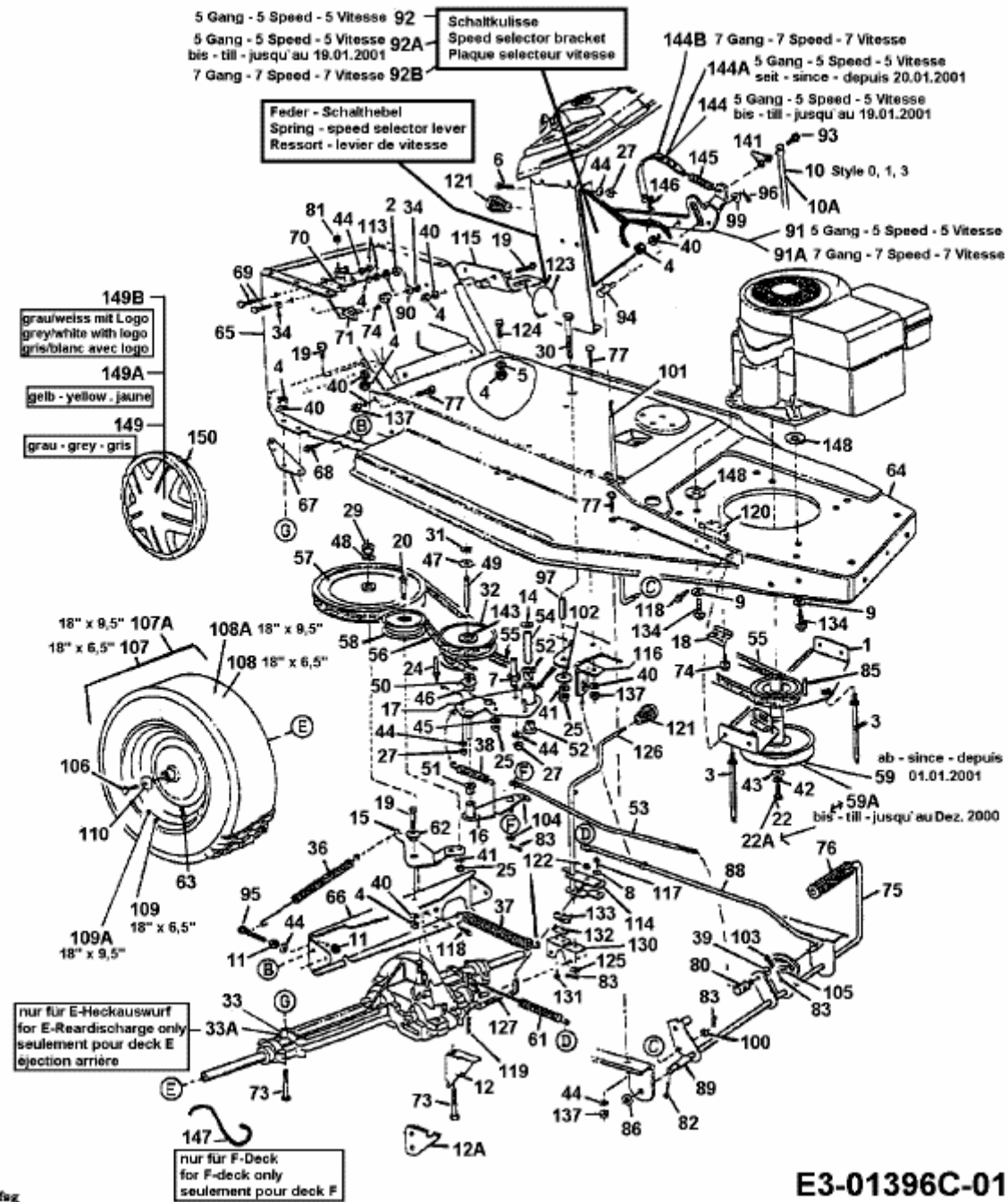

fog