

PINTO > 13B6064-600 (2007) > MOTORBEFESTIGUNG

MOTOR / ENGINE

14	Pos 14: Handstart-Motor nicht abgebildet/ Manual Start Engine not shown
14A	Pos 14A: E-Start-Motor nicht abgebildet/ E-Start Engine not shown

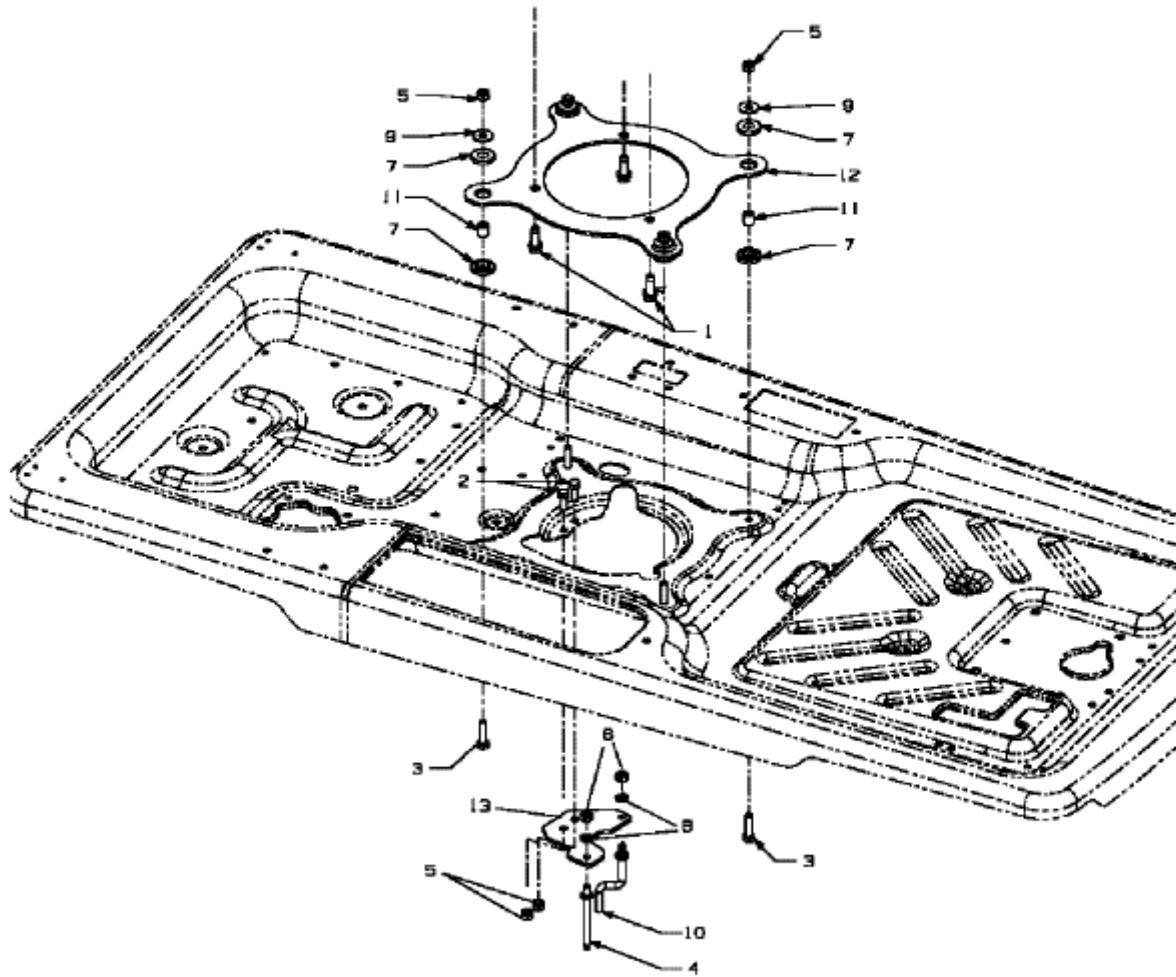

E3-02189A-01