

7

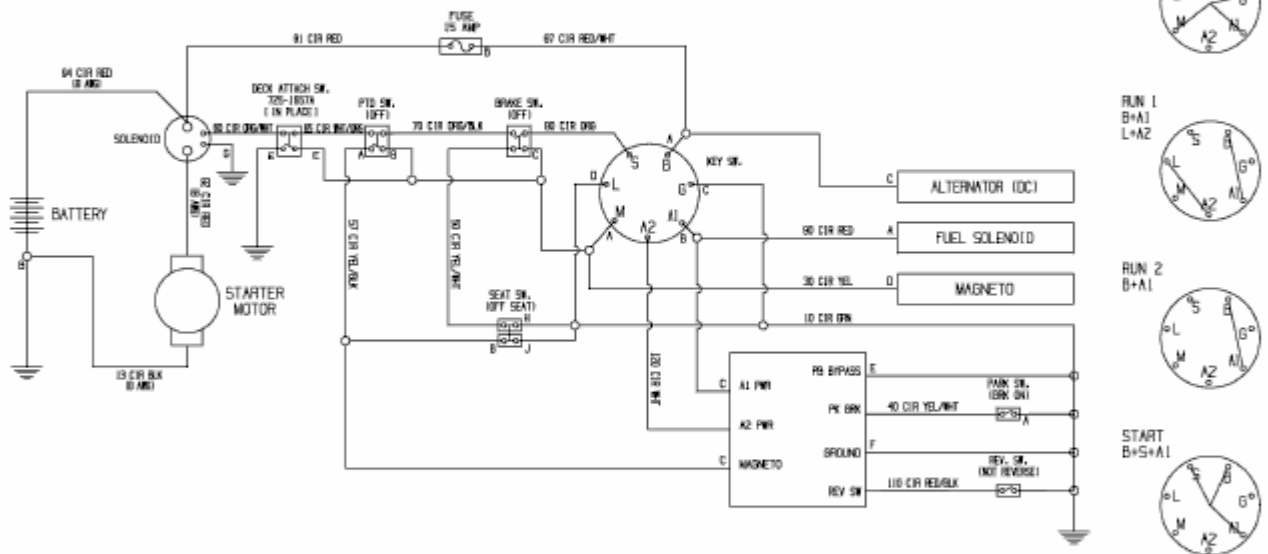

E3-09175A-02