

503 > 13B-332-611 (2006) > GRASFANGKORB

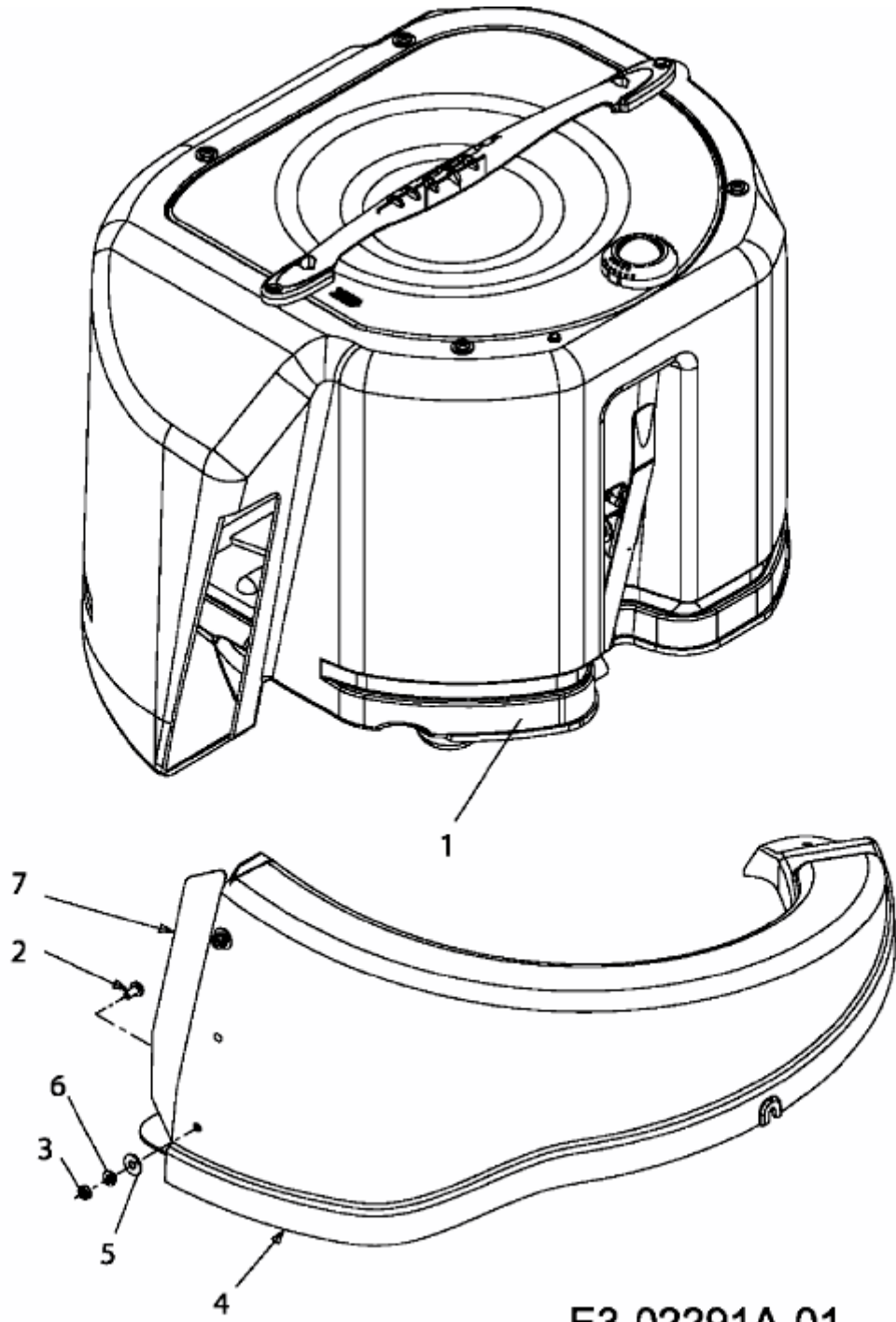

E3-02291A-01