

503 > 13B-332-611 (2006) > LENKUNG, VORDERACHSE

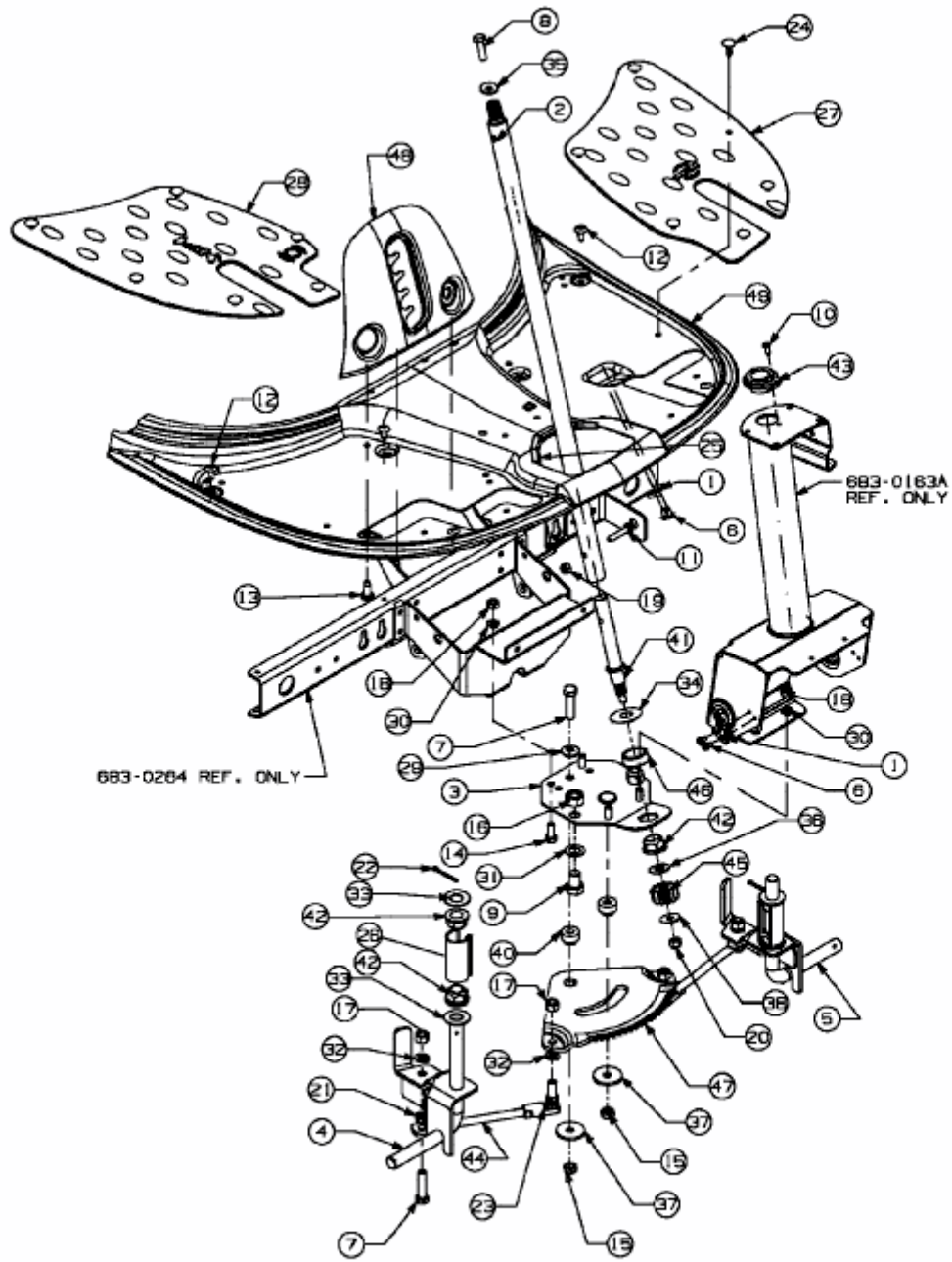

E3-02285A-01