

503 > 13B-332-611 (2006) > FAHRANTRIEB, MOTORKEILRIEMENSCHLEIBE

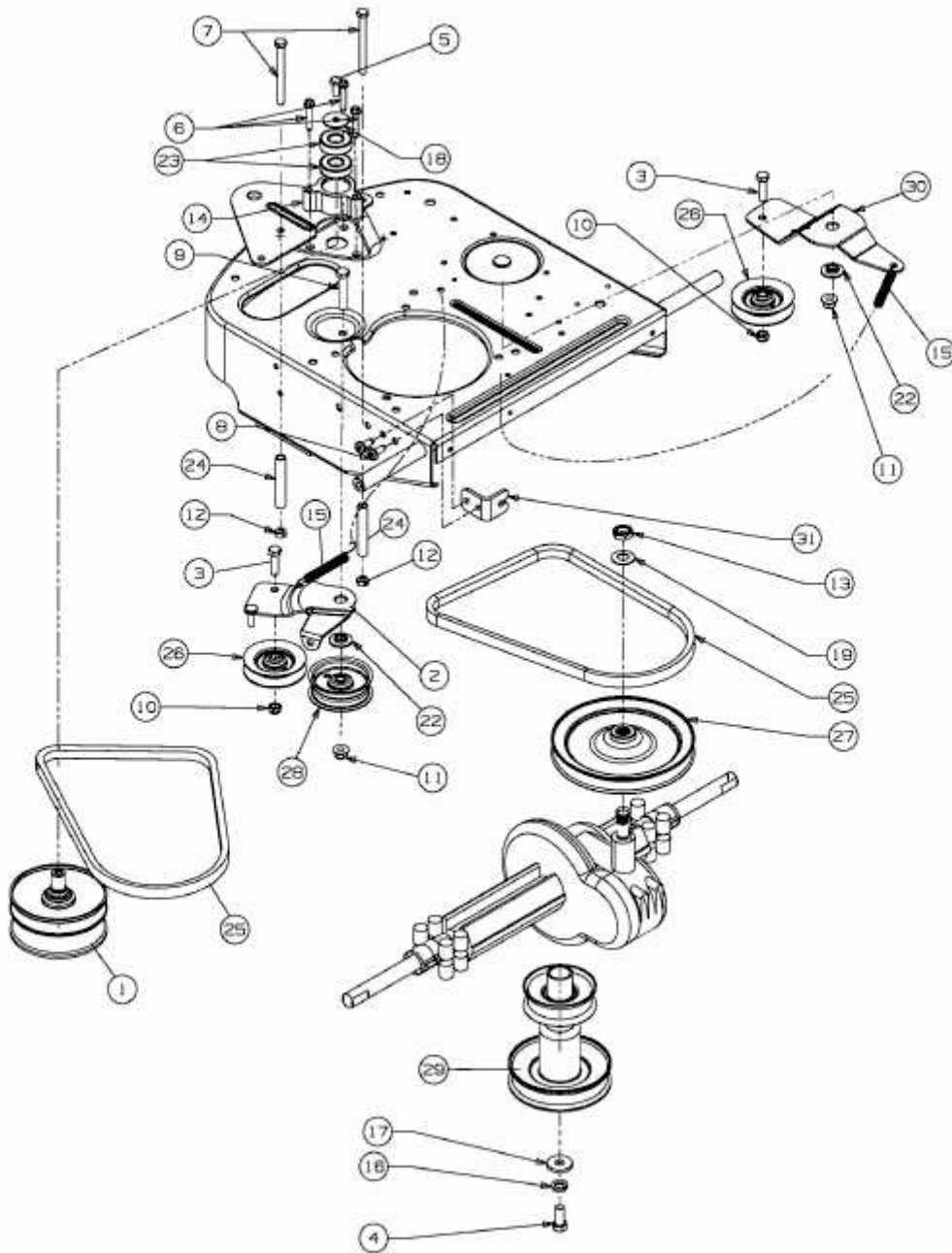

E3-02923A-01